

WFT-C^x and -C^{xs} 6-component wheel

Manual

Edition 6 - 19.02.2024



Disclaimer of liability

The contents of this documentation have been carefully checked for consistency with the hardware and software systems described. Nevertheless, it is impossible to completely rule out inconsistencies, so that we decline to offer any guarantee of total conformity.

We reserve the right to make technical modifications of the systems.

Copyright

© 2024 imc Test & Measurement GmbH, Germany

This documentation is the intellectual property of imc Test & Measurement GmbH. imc Test & Measurement GmbH reserves all rights to this documentation. The applicable provisions are stipulated in the "imc Software License Agreement".

The software described in this document may only be used in accordance with the provisions of the "imc Software License Agreement".

Open Source Software Licenses

Some components of imc products use software which is licensed under the GNU General Public License (GPL). Details are available in the About dialog.

A list of the open source software licenses for the imc measurement devices is located on the imc STUDIO/imc WAVE/imc STUDIO Monitor installation medium in the folder "*Products\imc DEVICES\OSS*" or "*Products\imc DEVICEcore\OSS*" or "*Products\imc STUDIO\OSS*". If you wish to receive a copy of the GPL sources used, please contact our tech support.

Notes regarding this document

This document provides important notes on using the device / the module. Safe working is conditional on compliance with all safety measures and instructions provided. The manual is to be used as a kind of reference book. You can skip the description of the modules you do not have.

Additionally, all accident prevention and general safety regulations pertinent to the location at which the device is used must be adhered to.

These instructions exclusively describe the device, **not how to operate** it by means of **the software!**

If you have any questions as to whether you can set up the device / module in the intended environment, please contact our tech support. The measurement system has been designed, manufactured and unit-tested with all due care and in accordance with the safety regulations before delivery and has left the factory in perfect condition. In order to maintain this condition and to ensure safe operation, the user must observe the notes and warnings contained in this chapter and in the specific sections applicable to the concrete device. Never use the device outside the specification.

This will protect you and prevent damage to the device.

Special notes

Warning

Warnings contain information that must be observed to protect the user from harm or to prevent damage to property.

Note

Notes denote useful additional information on a particular topic.

Reference

A reference in this document is a reference in the text to another text passage.

Table of contents

1 General introduction	6
1.1 Tech support	6
1.2 Service and maintenance	6
1.3 Legal notices	6
1.4 Explanation of symbols	9
2 Safety	11
3 Delivery and operation	14
3.1 After unpacking	14
3.2 Before commissioning	14
3.3 Notes on connecting	16
4 Maintenance and service	18
4.1 Maintenance	18
4.2 Calibration	18
4.3 Storage	18
4.4 Transport	18
5 WFT - 6-component wheel force transducer	19
5.1 Introduction	19
5.2 Usage	19
6 Fundamentals	20
6.1 Forces and Torques	21
6.2 Coordinate Transformation of the Measurement Values	23
6.3 Radial displacement	24
6.4 Axial displacement: Offset a	24
6.5 Sample rate	26
6.6 Zero Balance	26
7 Technical Components	27
7.1 Sensor with integrated electronics	27
7.2 WFT adaptor for stationary application	27
7.3 Hub adaptor, modified rim	28
7.4 WFT interface (CRFX/WFT-2)	29
7.5 CRFX/2000GP-WFT	30
7.6 CRFX/2000GP-WFT-UPS	31
8 Installation and Configuration	32
8.1 Installation of the sensor	32
8.2 CRFX/WFT-2 Hardware Setup	44
8.3 Configuration with imc STUDIO	44
8.4 imc WFT Assistant	59
9 Technical Specs	66
9.1 WFT sensors	66

9.2 CRFX module (CRFX/WFT-2) 67

Index 68

1 General introduction

1.1 Tech support

If you have problems or questions, please contact our tech support:

Phone: (Germany): **+49 30 467090-26**
E-Mail: hotline@imc-tm.de
Internet: <https://www.imc-tm.com/service-training/>

Tip for ensuring quick processing of your questions:

If you contact us **you would help us**, if you know the **serial number of your devices** and the **version info of the software**. This documentation should also be on hand.

- The device's serial number appears on the nameplate.
- The program version designation is available in the About-Dialog.
- For optimal support, we might require information as weight of vehicles to be tested, speed and max values of forces and torques. Specific information shared with us will always be kept privately.

Product Improvement and change requests

Please help us to improve our documentation and products:

- Have you found any errors in the software, or would you suggest any changes?
- Would any change to the mechanical structure improve the operation of the device?
- Are there any terms or explanations in the manual or the technical data which are confusing?
- What amendments or enhancements would you suggest?

Our [tech support](#)  will be happy to receive your feedback.

1.2 Service and maintenance

Our service team is at your disposal for service and maintenance inquiries:

E-Mail: service@imc-tm.de
Internet: <https://www.imc-tm.com/service>

Service and maintenance activities include, for example calibration and adjustment, service check, repairs.

1.3 Legal notices

Quality Management



imc Test & Measurement GmbH holds DIN EN ISO 9001 certification since May 1995 and DIN EN ISO 14001 certification since November 2023. You can download the CE Certification, current certificates and information about the imc quality system on our website:

<https://www.imc-tm.com/quality-assurance/>.

imc Warranty

Subject to the general terms and conditions of imc Test & Measurement GmbH.

Liability restrictions

All specifications and notes in this document are subject to applicable standards and regulations, and reflect the state of the art well as accumulated years of knowledge and experience. The contents of this document have been carefully checked for consistency with the hardware and the software systems described. Nevertheless, it is impossible to completely rule out inconsistencies, so that we decline to offer any guarantee of total conformity. We reserve the right to make technical modifications of the systems.

The manufacturer declines any liability for damage arising from:

- failure to comply with the provided documentation,
- inappropriate use of the equipment.

Please note that all properties described refer to a closed measurement system and not to its individual slices.

Important information for customers who want to adapt their own adaptors for the sensors

imc also manufactures customer specific adaptors for the sensors against payment, so that the sensors can be installed professionally at the customer's site and used according to the contract.

If customers produce the adaptors on their own request, imc points out the following as a precaution:

- The contractual usability of imc sensors requires that they are installed professionally with custom-made adaptors. Otherwise, the contractual usability and especially the compliance with the specifications given for the sensors cannot be guaranteed.
- The customer's claims for defects against imc for adaptors manufactured by the customer himself extend only to the sensors and not to the adaptors. imc does not assume any liability for defects that the imc sensors can be used with the adaptors manufactured by the customer according to the contract, especially that the specifications given for the imc sensors are met. If the customer makes the adaptors himself, imc is not liable for defects. This does not apply if the customer can prove that his own production is not the cause of the defect.
- Furthermore, the General Terms and Conditions of imc Test & Measurement GmbH apply.

Customized cable manufacturing

To comply with the limits for Class B equipment under Part 15 of the FCC Rules, all signal lines connected to the meter must be shielded and the shield must be connected.

Unless otherwise indicated, all connecting cables must not be long cables as defined by IEC 61326-1 (< 30 m). LAN cables (RJ 45) and CAN bus cables (DSUB-9) are excluded from this. Only cables with suitable properties for the task (e.g. isolation to protect against electric shock) may be used. Independently performed modifications to cables will void the manufacturer's functional warranty.

Guarantee

Each device is subjected to a 24-hour "burn-in" before leaving imc. This procedure is capable of detecting almost all cases of early failure. This does not, however, guarantee that a component will not fail after longer operation. Therefore, all imc devices are granted liability for a period of two years. The condition for this guarantee is that no alterations or modifications have been made to the device by the customer.

Unauthorized intervention in the device renders the guarantee null and void.

Notes on radio interference suppression

WFT-C^x and WFT-C^{xs} sensors satisfy the EMC requirements for an use in industrial settings.

Any additional products connected to the product must satisfy the EMC requirements as specified by the responsible authority (within Europe¹) in Germany the BNetzA - "Bundesnetzagentur" (formerly BMPT-Vfg. No. 1046/84 or No. 243/91) or EC Guidelines 2014/30/EU. All products which satisfy these requirements must be appropriately marked by the manufacturer or display the CE certification marking.

Products not satisfying these requirements may only be used with special approval of the regulating body in the country where operated.

All lines connected to the WFT-C^x or WFT-C^{xs} sensors should not be longer than 30 m and they should be shielded and the shielding must be grounded.

Note

The EMC tests were carried out using shielded and grounded input and output cables with the exception of the power cord. Observe this condition when designing your setup to ensure high interference immunity and low jamming.

¹ If you are located outside Europe, please refer the appropriate EMC standards used in the country of operation.

ElektroG, RoHS, WEEE, CE

The imc Test & Measurement GmbH is registered with the authority as follows:

WEEE Reg. No. DE 43368136

valid from 24.11.2005

Reference

<https://www.imc-tm.com/elekrog-rohs-weee/> and <https://www.imc-tm.com/ce-conformity/>

FCC-Notice

This product has been tested and found to comply with the limits for a Class B digital device, pursuant to Part 15 of the FCC Rules. These limits are designed to provide reasonable protection against harmful interference in a residential installation. This equipment generates, uses, and can radiate radio frequency energy and, if not installed and used in accordance with the instructions, may cause harmful interference to radio communications. However, there is no guarantee that interference will not occur in a particular installation. If this equipment does cause harmful interference to radio or television reception, which can be determined by turning the equipment on and off, the user is encouraged to try to correct the interference by one or more of the following measures:

- Reorient or relocate the receiving antenna.
- Increase the separation between the equipment and the receiver.
- Connect the equipment into an outlet on a circuit different from that to which the receiver is connected.
- Consult our tech support or an experienced technician for help.

Modifications

The FCC requires the user to be notified that any changes or modifications made to this product that are not expressly approved by imc may void the user's authority to operate this equipment.

1.4 Explanation of symbols



CE Conformity

see CE [chapter 1.2](#)



No household waste

Please do not dispose of the electrical/electronic device with household waste, but at the appropriate collection points for electrical waste, see also [chapter 1.2](#).

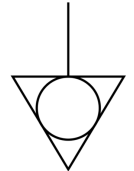

Potential compensation

Connection for potential compensation



Grounding

Connection for grounding (general, without protective function)



Protective connection

Connection for the protective conductor or grounding with protective function



Attention! General danger zone!

This symbol indicates a dangerous situation; Since there is insufficient space for indicating the rated quantity at the measuring inputs, refer to this manual for the rated quantities of the measuring inputs before operation.



Attention! Injuries from hot surfaces!

Surfaces whose temperatures can exceed the limits under certain circumstances are denoted by the symbol shown at left.



ESD-sensitive components (device/connector)

When handling unprotected circuit boards, take suitable measures to protect against ESD (e.g. insert/remove ACC/CANFT-RESET).



Possibility of electric shock

The warning generally refers to high measurement voltages or signals at high potentials and is located on devices suitable for such measurements. The device itself does not generate dangerous voltages.



DC, Direct Current

Supply of the device via a DC voltage source (in the specified voltage range)



RoHS of the PR China

The limits for hazardous substances in electrical/electronic equipment applicable in the PRC are identical to those in the EU. The restrictions are complied with (see [chapter 1.2](#)). A corresponding "China-RoHS" label is omitted for formal/economic reasons. Instead, the number in the symbol indicates the number of years in which no hazardous substances are released. (This is guaranteed by the absence of named substances).



Labeling integrated energy sources

UxxRxx are integrated in the symbolism. "U" stands for the installed UPS energy sources, if 0 = not installed. "R" stands for the installed RTC energy sources, if 0 = not installed. You can download the corresponding data sheets from the imc website:

<https://www.imc-tm.com/about-imc/quality-assurance/transport-instructions/>



Observe the documentation

Read the documentation before starting work and/or operating.



On/Off

On/Off button (no complete disconnection from the power supply)

2 Safety

This section provides an overview of all important aspects of protection of the users for reliable and trouble-free operation. Failure to comply with the instructions and protection notes provided here can result in serious danger.

Responsibility of the operator

The WFT 6-component wheel is for use in commercial applications. The user is therefore obligated to comply with legal regulations for work safety.

Along with the work safety procedures described in this document, the user must also conform to regulations for safety, accident prevention and environmental protection which apply to the work site. If the product is not used in a manner specified by the manufacturer, the protection supported by the product may be impaired.

The user must also ensure that any personnel assisting in the use of the WFT 6-component wheel have also read and understood the content of this document.

Operating personnel

This document identifies the following qualifications for various fields of activity:

- *Users of measurement engineering*: Fundamentals of measurement engineering. Basic knowledge of electrical engineering is recommended. Familiarity with computers and the Microsoft Windows operating system. Users must not open or structurally modify the measurement device.
- *Qualified personnel* are able, due to training in the field and to possession of skills, experience and familiarity with the relevant regulations, to perform work assigned while independently recognizing any hazards.

Warning

- **Danger of injury due to inadequate qualifications!**
- Improper handling may lead to serious damage to personnel and property. When in doubt, consult qualified personnel.
- Work which may only be performed by trained imc personnel may not be performed by the user. Any exceptions are subject to prior consultation with the manufacturer and are conditional on having obtained corresponding training.

Special hazards

This segment states what residual dangers have been identified by the hazard analysis. Observe the safety notes listed here and the warnings appearing in subsequent chapters of this manual in order to reduce health risks and to avoid dangerous situations. Existing ventilation slits on the sides of the device must be kept free to prevent heat accumulation inside the device. Please operate the device only in the intended position of use if so specified.

Danger



Lethal danger from electric current!

- Contact with conducting parts is associated with immediate lethal danger.
- Damage to the insulation or to individual components can be lethally dangerous.

Therefore:

- In case of damage to the insulation, immediately cut off the power supply and have repair performed.
- Work on the electrical equipment must be performed exclusively by expert electricians.
- During all work performed on the electrical equipment, it must be deactivated and tested for static potential.

Injuries from hot surfaces!



- Devices from imc are designed so that their surface temperatures do not exceed limits stipulated in EN 61010-1 under normal conditions.

Therefore:

- Surfaces whose temperature can exceed the limits under circumstances are denoted by the symbol shown at left.

Industrial safety

We certify that the WFT 6-component wheel in all product configuration options corresponding to this documentation conforms to the directives in the accident prevention regulations in "Electric Installations and Industrial Equipment" (DGUV Regulation 3)*. This confirmation applies exclusively to the CLS^x sensor system, but not to all other components included in the scope of delivery.

This certification has the sole purpose of releasing imc from the obligation to have the electrical equipment tested prior to first use (§ 5 Sec. 1, 4 of DGUV Regulation 3). This does not affect guarantee and liability regulations of the civil code.

* previously BGV A3.

Observe notes and warnings

Devices from imc have been carefully designed, assembled and routinely tested in accordance with the safety regulations specified in the included certificate of conformity and has left imc in perfect operating condition. To maintain this condition and to ensure continued danger-free operation, the user should pay particular attention to the remarks and warnings made in this chapter. In this way, you protect yourself and prevent the device from being damaged.

Read this document before turning on the device for the first time carefully.

Warning

Before touching the device sockets and the lines connected to them, make sure static electricity is diverted to ground. Damage arising from electrostatic discharge is not covered by the warranty.

3 Delivery and operation

3.1 After unpacking

The delivery must be checked for completeness and transport damage immediately upon receipt. In case of externally visible transport damage, proceed as follows:

- Do not accept the delivery or accept it only with reservations,
- Note the extent of the damage on the transport documents/delivery bill of the carrier,
- Initiate a complaint.

After unpacking, check the unit for mechanical damage and loose parts inside. If there is transport damage, imc customer service must be informed immediately. The unit must then not be put into operation.

Check the supplied accessories for completeness according to the scope of delivery.



Note

Complain about any defect as soon as it is detected. Claims for damages can only be asserted within the applicable complaint periods.

3.2 Before commissioning

Before using the WFT-C^x or -C^{xs} sensors, the user must have read and understood the manual, especially the instructions for installation and use. Of particular importance are the hub and rim adapters, which must be inspected and maintained according to the instructions in this manual - before and after each test drive.

The bolts used must be tightened according to the specification. After heavy force or long test drives, the strength of all wheel nuts and adapter bolts must be checked to ensure safe and reliable operation. Loose fasteners can damage system components.

Rims that have been subjected to extreme endurance tests on the test track must not be used for further driving tests.

Before putting the WFT-C^x and -C^{xs} into operation, the user must have read and understood the instruction manual, especially its information concerning installation and operation. Safe working is conditional on compliance with all safety measures and instructions provided. It is particularly important that the hub and rim adapters and the wheel bolts are inspected and maintained – before and after each test drive.

Assembly bolts must be properly tightened according to specification. Following extreme loading or extended tests the tightness of all lug nuts and rim/hub adapters bolts should be re-checked to ensure safe and reliable operation. Loose fasteners can lead to damage of system components.

Rims which have been subjected to extreme durability test loads on the proving ground test track must not be used for further test drives on public roads. Operation of the WFT-sensor in public traffic is at the user's own risk.



Warning

WFT-C^x and -C^{xs} test equipment on public roads

Driving with WFT-C^x and -C^{xs} test equipment on public roads is done at the sole risk of the user/purchaser.

It should be clearly understood that the proper use of WFT testing equipment normally involves short-term vehicle dynamic and durability tests under specially prepared proving ground and test track road conditions. The data obtained is then most often used to establish load profiles and spectra for use on fatigue machines, tire testing / rim test and road load simulation rigs.

Any driving tests which replicate vehicle misuse such as colliding with the curb, driving over open road gullies, or on extreme road conditions may significantly reduce the working life of your WFT-C^x and -C^{xs}. In order to keep the mechanical stress on the sensor as low as possible, restrict these kind of tests to a minimum.

The WFT-C^x and -C^{xs} may only be used to set up test rigs for suspension durability or tire tests. As soon as the desired load profile has been programmed, the WFT-C^x and -C^{xs} is to be removed from the test rig. Under no circumstances the device is to be used as a sensor in the feedback loop of a test rig for a longer period of time!

Additionally, the WFT-C^x and -C^{xs} is not designed for extensive long-term tests with dozens or hundreds of test-track loops, e.g. for durability tests of suspension and tires. Such tests may only be performed with standard wheels, as is usual in the development of WFTs and simulators.

The WFT-C^x and -C^{xs} is waterproof according to IP67. In order to protect the electronic components from ingress of moisture, the device has to be cleaned and put into a dry environment immediately after usage in rain or in moist conditions. Do not store the sensors in a moist environment.

Do not store the WFT-C^x and -C^{xs} in a moist environment!

3.3 Notes on connecting

3.3.1 Precautions for operation

Certain ground rules for operating the system, aside from reasonable safety measures, must be observed to prevent danger to the user, third parties, the device itself and the measurement object. These are the use of the system in conformity to its design, and the refraining from altering the system, since possible later users may not be properly informed and may ill-advisedly rely on the precision and safety promised by the manufacturer.

Note

If you determine that the device cannot be operated in a non-dangerous manner, then the device is to be immediately taken out of operation and protected from unintentional use. Taking this action is justified under any of the following conditions:

- I. the device is visibly damaged,
- II. loosed parts can be heard within the device,
- III. the device does not work,
- IV. the device has been stored for a long period of time under unfavorable conditions (e. g. outdoors or in high-humidity environments).

1. Observe the specs in the chapter "Technical Specs " and the application hints about the individual system in order to prevent damage to the unit through inappropriate signal connection.
2. Note when designing your experiments that all input and output leads must be provided with shielding which is connected to the ground ("CHASSIS") at one end in order to ensure high resistance to interference and noisy transmission.
3. Unused, open channels (having no defined signal) should not be configured with sensitive input ranges since otherwise the measurement data could be affected. Configure unused channels with a broad input range or short them out. The same applies to channels not configured as active.
4. Avoid prolonged direct exposure to sunlight.

3.3.2 Important Safety Considerations

Safety of all persons operating or observing test vehicles is a **primary concern** when using WFT-C^x and -C^{xs}. Please regard the following safety considerations:

- It is strongly recommended to create and use a check list of critical items and operations that must be verified before and after each test routine.
- **Integration and installation is to be done by a qualified and trained person.** It is recommended to inspect and test the installation by a second qualified person to verify compliance with the requirements.
- For measurements with wheel force transducers, the standard wheels of the test vehicle are replaced by the WFT-C^x and -C^{xs}.



Attention

Proper installation, tightening of all fasteners and continuous strength checks are extremely important for the safety of all parties involved.

- The following **components must properly tightened and checked on a regular basis**: lug nuts and/or lug bolts, test rim attachment bolts, hub adapter attachment bolts, attachment bolts of stator unit, fastening of stator cable.
- **Upon completion of testing**, the remaining tightness of all fasteners is to be checked. Usage of the WFT-C^x and -C^{xs} with loose fasteners is a safety risk and may lead to unprecise measurement data.



Reference

Please observe important information for customers who want to make their own adaptors for the sensors.

4 Maintenance and service

4.1 Maintenance

imc recommends performing a service check every 12 months. An imc service check includes system maintenance in accordance with the service interval plan as specified by the manufacturer and a complete function test (maintenance, inspection and revision).

Maintenance (*repair*) work may only be carried out by qualified personnel from imc Test & Measurement GmbH.

For service and maintenance work, please use the [service form](#) that you download from our website and fill out: <https://www.imc-tm.com/service>



Reference

Device certificates and calibration protocols

Detailed information on certificates, the specific contents, underlying standards (e.g. ISO 9001 / ISO 17025) and available media (pdf etc.) can be found on [our website](#), or you can contact us directly.

4.2 Calibration

The manufacturer recommends a yearly calibration of the WFT-C^x or the -C^{xs} sensors.



Reference

Calibration

For further information on the calibration process, please contact imc or your local distributor.

4.3 Storage

When storing the WFT-C^x or the -C^{xs}, it has to be protected against:

- Electrostatic charging (which may lead to destruction of electronic parts)
- Humidity (which leads to corrosion)

Permissible **storage temperature**: -10...40 °C



Note

Storage

The cables required for operation of the WFT-C^x or the -C^{xs} sensors must be stored without kinks. The individual modules must not be damaged mechanically when being packed.

4.4 Transport

Only transport the device in the original packaging or in suitable packaging that provides protection against impact and shock. In case of damage, please inform the customer service immediately. Transport damage is excluded from the warranty claim.

5 WFT - 6-component wheel force transducer

In motor vehicle development, 6 component wheel force transducers (WFTs) are used to determine and record forces and torques at the wheels during test drives – in all three dimensions, resulting in 3 forces (F_x , F_y , F_z) and 3 torques (M_x , M_y , M_z).

The measurement results generate the data used for computer simulations or as input parameters for test rig systems. The WFT-C^x and the WFT-C^{xs} is a wheel force transducer which is not only waterproof, but furthermore provide a higher thermal and mechanic load to perform even in off road tests of cars in any weather conditions.

The entire signal processing system relies on extremely short signal lead lengths. Each strain gauge signal is digitized individually, all channels are recorded simultaneously. The wheel force transducers (WFTs) can be used on small to large cars (minimum wheel size: 14 inches), but also on SUVs and light trucks (maximum hub diameter: 5.5 inches).

5.1 Introduction

30 years of experience in the development and application of strain gauge based wheel force transducers (WFTs) has resulted in the development the WFT-C^x and -C^{xs} sensors.

The WFT-C^x and -C^{xs} are up to date and highly powerful systems to measure forces and torques on the wheels during test drives, e.g. for road load data generation.

Due to its easy and comfortable operation, setup times are significantly reduced. Measurement values are already available to you in real time during your test.

Your system consists of the robust sensor unit with integrated electronics for signal processing, digitization as well as digital data transfer and the control unit for recording and converting the sensor data.

Your benefits at a glance

- Waterproof sensor unit (IP66, IP67) for test drives in all weather conditions
- Sensor with high linearity and extremely low thermal drift
- Removable stator for fast access to lug nuts and for convenient balancing
- Digital data transmission from rotor unit to stator unit
- Integrated in imc STUDIO for fast configuration, data recording, data analysis and report generation
- System is ready to measure within just a few minutes (including offset compensation of the rotating system)
- Non-volatile storage of calibration data in the sensor
- The imc CRONOS*flex* (CRFX) system can be equipped with any desired extra amplifiers and/or CAN-boards for synchronized capture of all signals.

5.2 Usage

In motor vehicle development, 6 component wheel force transducers (WFTs) are used to determine and record forces and torques on the wheels during test drives – in all three dimensions, resulting in 3 forces (F_x , F_y , F_z) and 3 torques (M_x , M_y , M_z). The measurement results generate the data used for computer simulations or as input parameters for test rig systems.

6 Fundamentals

The ring-shaped wheel which carries the sensors is installed between the vehicle wheel's mounting attachment (i.e. the five lugs protruding from the wheel hub) and the rim, and is thus positioned directly in the path of the mechanical force applied. The measurement wheel's inner and outer rings are connected inside by rigid bars which, in response to the force applied, undergo warping which is measured by the strain gauge sensors.

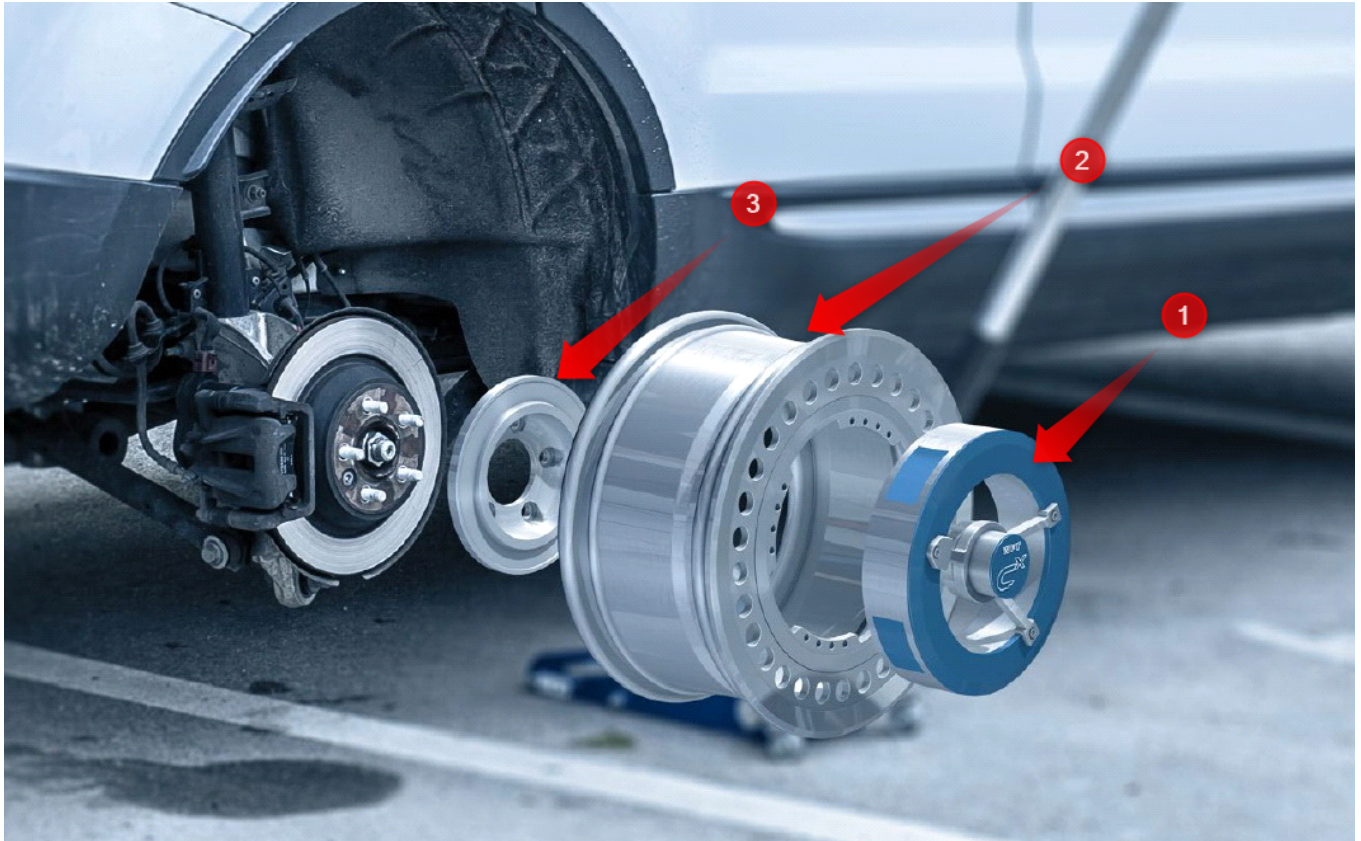

Fig. 1: WFT components: 1 = WFT; 2 = modified rim; 3 = hub adaptor

The edge of the measuring wheel is connected to the inner rotor, in which the stator is mounted, via a co-rotating Y-bar. This stator is held in place by a support rod system attached to the vehicle body (fender). In addition to inductive power transmission and contactless data transmission, the stator also contains the angle information. It has a LEMO socket for connection with the CRFX/WFT-2 receiver module.

6.1 Forces and Torques

The WFT-C^x and -C^s is a device to measure the forces and torques at the vehicle's wheels in all three spatial directions. Please see your sensor's spec sheet for the maximum forces and torques allowed. The Fig. 2 to Fig. 4 indicates the designations of the spatial dimensions in relation to the vehicle's forward motion.

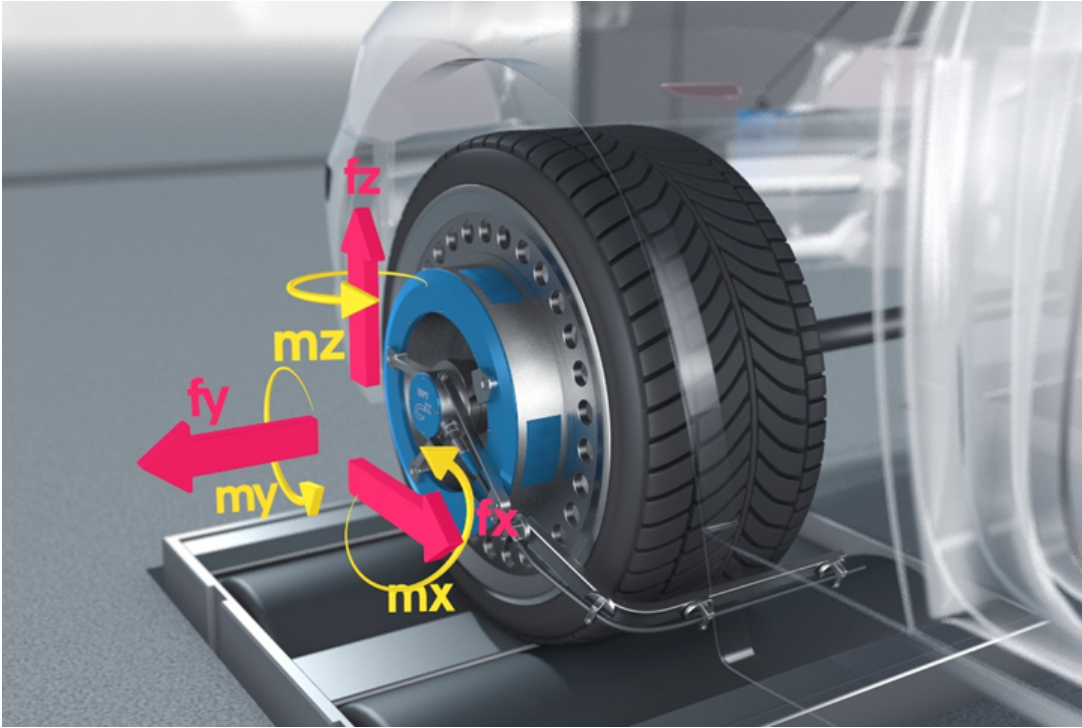

Fig. 2: Forces and moments in the wheel coordinate system on the left wheel

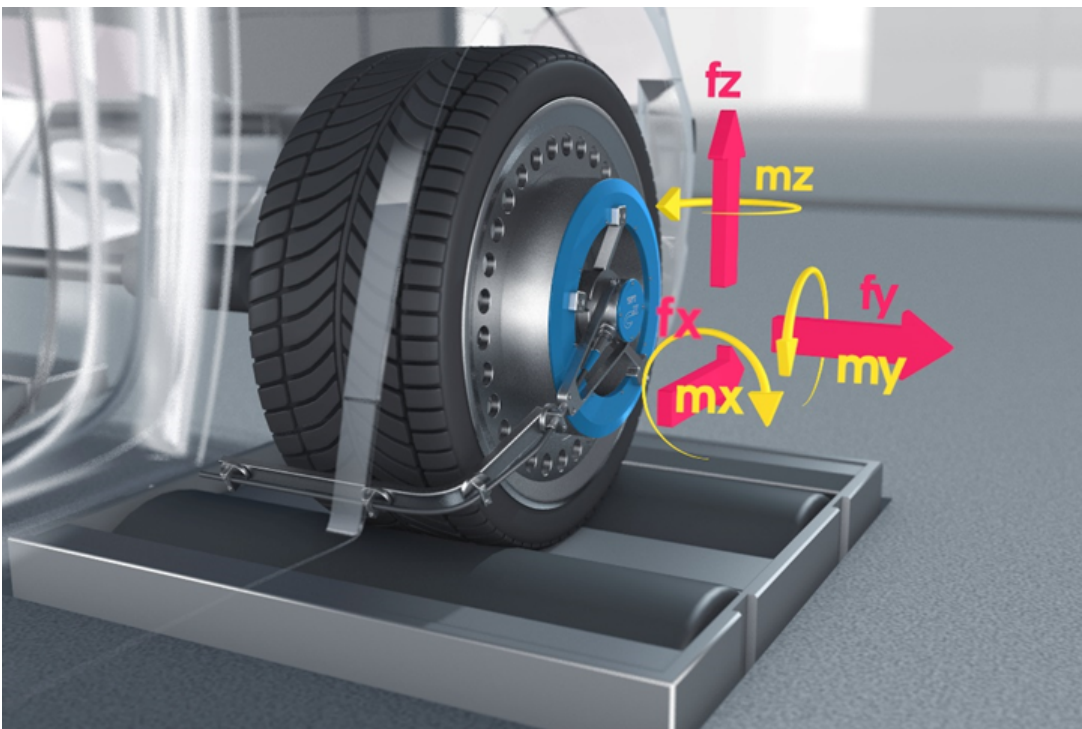

Fig. 3: Forces and moments in the wheel coordinate system on the right wheel

In the receiver unit, the measurement values recorded are transformed from the rotating coordinate system of the wheel to the stationary coordinate system of the vehicle, (see [Coordinate Transformation of the Measurement Values](#) ²³).

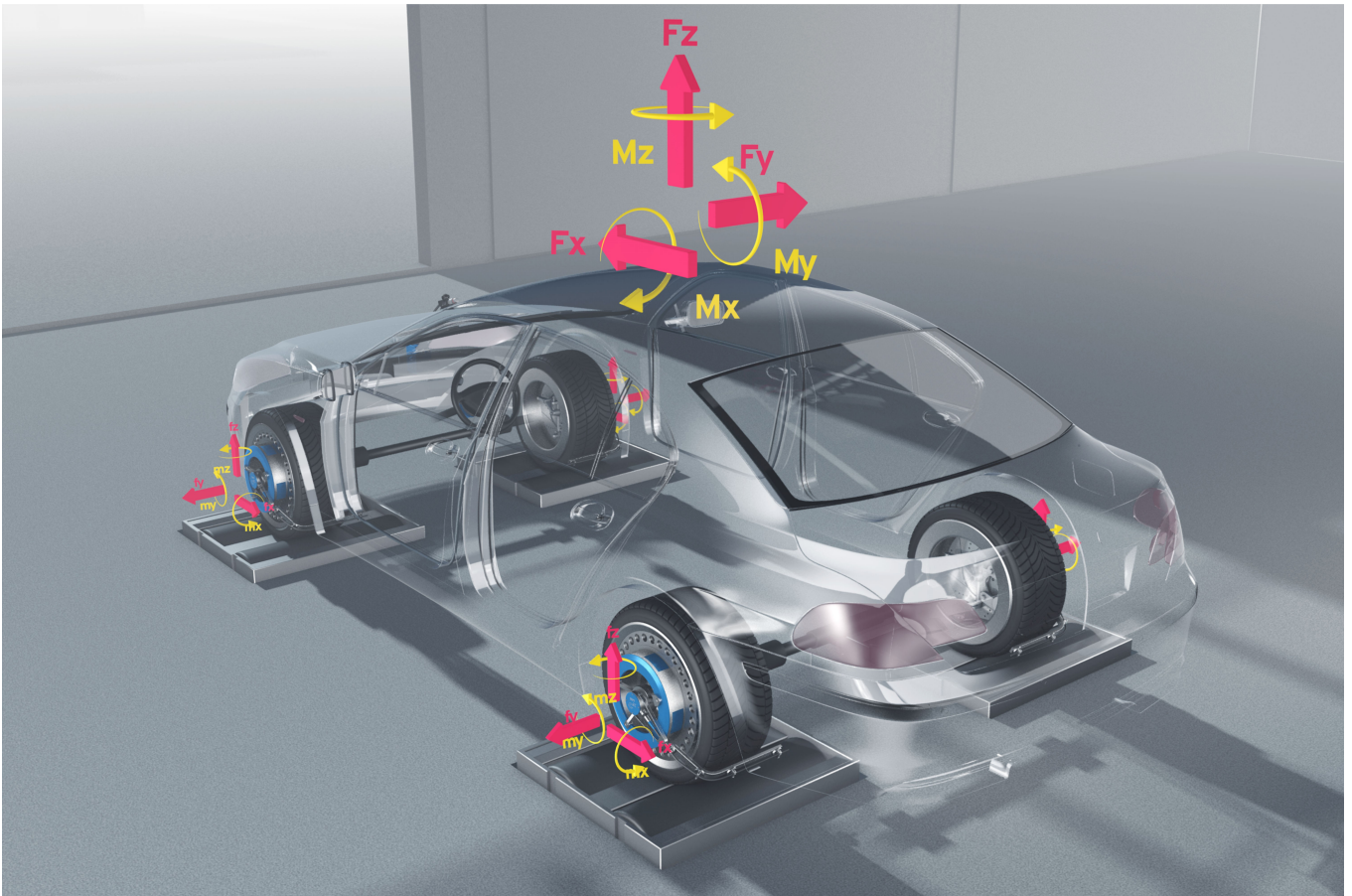

Fig. 4: Forces and moments in the vehicle coordinate system

6.2 Coordinate Transformation of the Measurement Values

The forces and torques on the wheel are recorded by the rotating WFT-C^x or the -C^{xs}. For further analysis, it is useful to transform these forces to the non-rotating vehicle coordinate system.

The following signals are transmitted to the receiver unit:

- f_x, f_y, f_z , rotating
- m_x, m_y, m_z , rotating
- $\sin \varphi, \cos \varphi$ of the rotational angle
- $Temp$ Temperature
- Aux auxiliary input

The CRFX/WFT-2 module resolves the output signals from the rotating WFT coordinate system to the stationary vehicle coordinate system using the following formulas:

- $F_{x'}$ vehicle left side = $-1 \cdot (f_x \cos \phi - f_z \sin \phi)$
 - $F_{x'}$ vehicle right side = $f_x \cos \phi - f_z \sin \phi$
 - $F_{y'}$ vehicle left side = $-f_y$, rotating
 - $F_{y'}$ vehicle right side = f_y , rotating
 - $F_{z'}$ vehicle right and left side = $f_z \cos \phi + f_x \sin \phi$
 - $M_{x'}$ vehicle left side = $-1 \cdot [(m_x \cos \phi - m_z \sin \phi) - a (f_z \cos \phi + f_x \sin \phi) + (f_y \cdot r)]$
 - $M_{x'}$ vehicle right side = $(m_x \cos \phi - m_z \sin \phi) - a (f_z \cos \phi + f_x \sin \phi) + (f_y \cdot r)$
 - $M_{y'}$ vehicle left side = m_y , rotating
 - $M_{y'}$ vehicle right side = $-m_y$, rotating
 - $M_{z'}$ vehicle right and left side = $(m_z \cos \phi + m_x \sin \phi) + a (f_x \cos \phi - f_z \sin \phi)$
 - number of revolutions
 - angle
 - angular speed
- with

r = radial displacement in mm.

For $r = 0$, M_x is transferred from street level to the center of the hub.

a = axial offset, i.e. deviation of the WFT's centerline from the wheel centerline (in mm).

Note

Consideration of axial offset is crucial for precision of M_x and M_z (see [Compensation "Axial displacement"](#)  58).

6.3 Radial displacement

Please set this parameter, the radial displacement r , only if you want to place the coordinate system

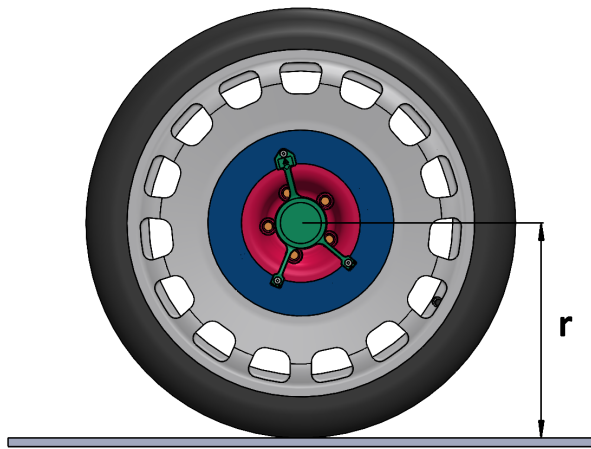

Fig. 5: Radial displacement r to the road

from the wheel center e.g. to the road. The additional torque generated by the F_y forces is calculated out. Compare the [formulas for \$M_x\$ on page 17](#)^[23] and: [compensation of radial displacement](#)^[58].



By entering the radial displacement r the reference plane of M_x is defined. Normally you can leave $r = 0$. If you want to place the zero point of the coordinate system on the road, select r as in Fig. 5. Compare the [formulas on p. 17](#)^[23], also for all other cases.

6.4 Axial displacement: Offset a

The WFT- C^x and - C^{xs} , and often also the hub adaptor, are not mounted axially in the center of the wheel, and thus an offset is created along the axis of the wheel, the so-called offset a . Since forces act orthogonally on this axis, torques are created depending on the size of the offset a , which act on the x and z plane - crosstalk occurs. However, these errors can be eliminated by the software. For this purpose, the offset a must be entered into the program.

The offset a shifts the reference plane for M_x and M_z .

Reference

See also [Compensation of axial displacement](#)^[58]

To determine the offset a , we define the following quantities (see [Fig. 6](#)^[25]):

ET: Einpresstiefe in mm. It is the distance from the wheel center to the inner flange surface of the hub adaptor. If the inner flange surface of the hub adaptor lies axially on the inner side of the wheel (i.e. the flange surface lies in such a way that, viewed from the WFT, it extends beyond the center of the wheel), the sign of the offset becomes negative. In the Fig. 6, the offset is positive because, viewed from the center of the wheel, the WFT and the inner flange surface are on the same side.

HO: The hub offset in mm. It is equal to the height of the hub adaptor in axial direction, or in other words, the distance from the inner flange surface, which is connected to the wheel hub, to the outer flange surface to which the WFT is attached.

RO: The rim offset in mm. It indicates the distance from the wheel center to the outer flange surface of the hub adaptor and is calculated from $ET + HO$.

For the **WFT- C^x** : 28 mm. The offset from the center of the WFT- C^x to the flange surface where the WFT- C^x is attached to the hub adaptor.

For the **WFT- C^{xs}** : 23.5 mm. The offset from the center of the WFT- C^{xs} to the flange surface where the WFT- C^{xs} is attached to the hub adaptor.

Axial displacement

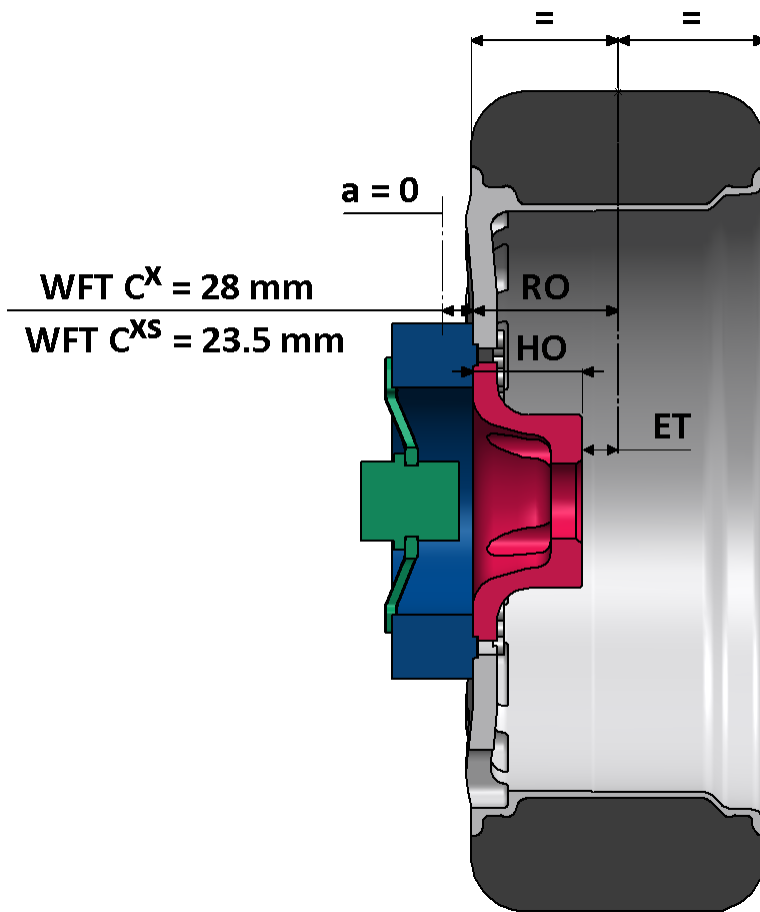

Fig. 6: Axial displacement: Offset a

Overview of axial offset for the WFT-C^x and -C^{xs}: ET = Einpresstiefe, HO = hub offset, RO = rim offset.
 Modified rim (grey), hub adaptor (red), WFT-C^x (blue), rotary transformer ("Y", green)

Reference point = wheel center:

$$a = 28 \text{ mm} + HO + ET = 28 \text{ mm} + RO$$

Reference point = wheel hub:

$$a = 28 \text{ mm} + HO$$

Reference point = wheel center:

$$a = 23.5 \text{ mm} + HO + ET = 23.5 \text{ mm} + RO$$

Reference point = wheel hub:

$$a = 23.5 \text{ mm} + HO$$

Please contact imc for further information with your individual application.

6.5 Sample rate

With the WFT-C^x and the -C^{xs}, sample rates of up to 10 kHz per channel are possible with the [CRFX/WFT-2 module](#)²⁹. A common sampling rate and filter settings apply to all of a connector's channels.



Reference

Configuration in imc STUDIO

The sample rate settings of your WFT system are modified with the configuration software imc STUDIO, see [Configuration imc STUDIO](#)⁴⁴.

6.6 Zero Balance

With the WFT-C^x and the -C^{xs}, 3 different methods of zero balancing are available to match your individual measurement task:

- [Operating Mode "mobile \(rotary\)"](#)⁵⁵
- [Operating Mode: "mobile \(stationary\)"](#)⁵⁶
- [Operating mode: "stationary"](#)⁵⁷

The zero offset is stored permanently within the WFT-C^x and the -C^{xs} electronics.



Note

Offset error

Accurate zero balancing is crucial for precise WFT measurements, as each error in zero balancing causes a systematic error in the measurement data. After coordinate transformation from the rotating to the stationary coordinate system, offset errors appear as a periodic interference signal.

7 Technical Components

7.1 Sensor with integrated electronics



Fig. 7: WFT-C^x measurement wheel with stator for mobile applications

Reference

Please find [here the technical specs](#) 

7.2 WFT adaptor for stationary application

For stationary applications, the stator unit for mobile applications can be replaced by this module.



Fig. 8: WFT-C^x adaptor for test rig applications

7.3 Hub adaptor, modified rim



Fig. 9: WFT hub adaptor (left) and modified rim (right)

The hub adaptors and modified rims have been manufactured according to your specifications. For further information concerning your individual application, please contact imc or your local distributor.

7.4 WFT interface (CRFX/WFT-2)

The WFT-2 is a imc CRONOSflex module for the capture of data from two WFT sensor systems. WFT sensor systems are used to determine and record forces and torques at the wheels during test drives - in all three dimensions, resulting in 3 forces and 3 torques. The measurement results generate the data used for computer simulations or as input parameters for test rig systems.

Highlights

- Power supply of the sensor systems
- graphical wizard for the recording of the measurement results



Fig. 10: CRFX/WFT-2 front panel

imc CRONOSflex - Frameless expansion, flexible modularity

The imc Click Mechanism and extruded aluminum case provide a firm mechanical and electrical connection. As a result, no mainframe or rack is needed.

An imc CRONOSflex system uses EtherCAT as an "internal" system bus for connecting various modules to the main base unit (CRFX-400 / CRFX-2000G).

With the system bus, all imc CRONOSflex modules are guaranteed to be synchronized with each other. This allows various modules to be either connected in one central block or connected via standard network cables in a spatially distributed system.

The measuring system formed in this way is in turn connected via a standard Ethernet connection (LAN / WLAN) with a PC that functions as a configurator and measurement data sink.



Fig. 11: imc click mechanism



Fig. 12: imc CRONOSflex distributed system

7.5 CRFX/2000GP-WFT



Abb. 13 (v.l.n.r.): CRFX/HANDLE-POWER, CRFX/2000GP-WFT-UPS, HANDLE-R, CRFX/WFT-REMOTE

Das CRFX-2000GP-WFT basiert auf der CRFX-2000GP Basiseinheit. Grundsätzlich gilt das Handbuch der imc CRONOS Gerätefamilie, sowie das Datenblatt der CRFX Basiseinheit.

Die CRFX-2000GP-WFT Basiseinheit ist mit einem modifizierten, digitalen Multiboard ausgestattet. Die WFT Remote Buchse, Typ LEMO.1B (7-polig) ersetzt DI9..16 (DSUB-15). Über diesen LEMO Anschluss wird die Fernbedienung (CRFX/WFT-REMOTE) angeschlossen, siehe Abbildung 0.

Die vier LEDs auf der Fernbedienung WFT-REMOTE werden über die folgenden digitalen Bits gesteuert:

- DO Bit 5 = LED vorne links (vl)
- DO Bit 6 = LED vorne rechts (vr)
- DO Bit 7 = LED hinten links (hl)
- DO Bit 8 = LED hinten rechts (hr)

Der Action Button steuert das DI Bit 16.

Verweis

The accessories supplied and current information on the current package (sales item), item no. 11900197 can be found in [a separate document](#).

7.6 CRFX/2000GP-WFT-UPS



Abb. 14 (v.l.n.r): CRFX/HANDLE-LI-IO-L, CRFX/2000GP-WFT-UPS, HANDLE-R

Reference

The accessories supplied and current information on the current package (sales item), item no. 11900197 can be found in [a separate document](#).

8 Installation and Configuration

8.1 Installation of the sensor

8.1.1 Overview

The ring-shaped measuring wheel (WFT) with the sensor system is mounted between the wheel hub and the modified rim by means of a hub adapter and is thus in the direct path of mechanical power transmission. The inner ring and outer ring of the measuring wheel body are internally connected by bending beams which deform due to the force transmission. This deformation is detected by strain gauge sensors.

The hub adapter is also called inner adapter, the modified rim is called outer adapter.

Reference

Please consider on the [imc website](#) a short movie showing the WFT-C^x and the -C^{xs}-assembly.

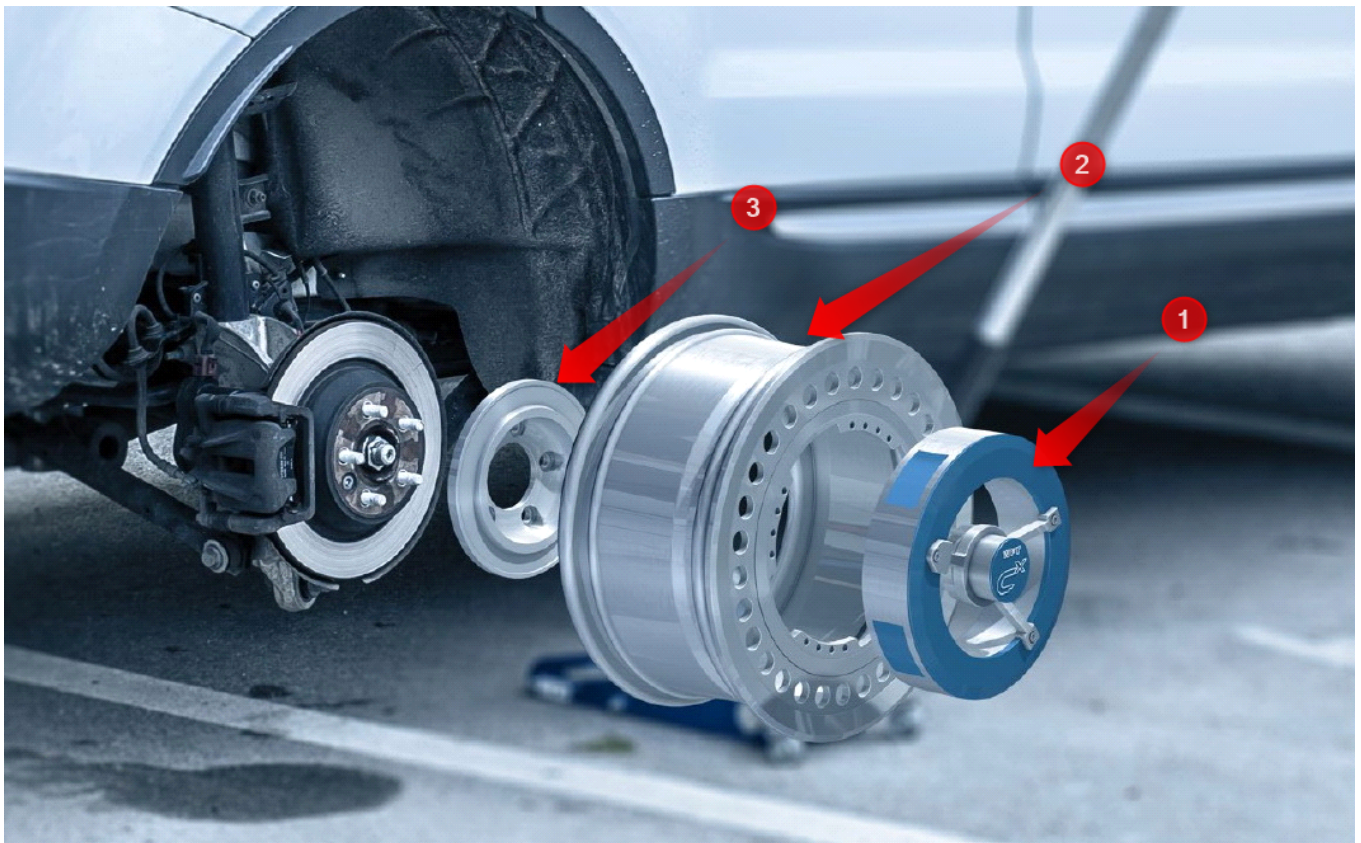

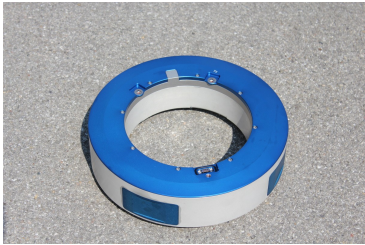





Fig. 15: WFT-C^x and -C^{xs} - mounting scheme

Legend for the Fig. 15:



- 1 WFT-C^x
- 2 modified rim
- 3 hub adaptor

8.1.2 Check list for the WFT installation

Required materials and tools (copy template)

Component	example photo	available
WFT-C ^x or -C ^{xs}		left front wheel: SN: right front wheel: SN: left rear wheel: SN: right rear wheel: SN:
Rotary transmitter ("Y")		left front wheel: SN: right front wheel: SN: left rear wheel: SN: right rear wheel: SN:
Wheel hub adaptor		left front wheel: type: right front wheel: type: left rear wheel: type: right rear wheel: type:
Specially made rim on which the tire is already mounted		left front wheel: type: right front wheel: type: left rear wheel: type: right rear wheel: type:
Suitable torque supports front wheel (example picture)		left front wheel: right front wheel:
Suitable torque supports rear wheel (example picture)		left rear wheel: right rear wheel:

Required materials and tools (copy template)

Component	example photo	available
Torque wrench (up to 80 Nm) with extension and 16 mm socket		
Screws (according to screwing instructions)		<p>left front wheel: SN:</p> <p>right front wheel: SN:</p> <p>left rear wheel: SN:</p> <p>right rear wheel: SN:</p>

Screwing instructions
in the current version

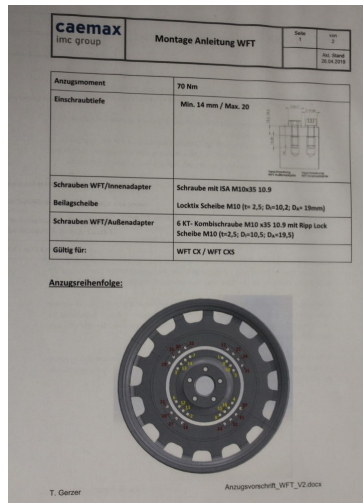

Cable tie / adhesive tape



8.1.3 Mounting

Screwing of external adaptor and WFT

Screw the modified rim (= external adaptor) to the WFT. It is essential to observe the current screwing instructions. The tire must already be mounted on the rim.



Attention

Observe the screwing instructions

It is mandatory that the screws are attached in accordance with the **current screwing instructions**.

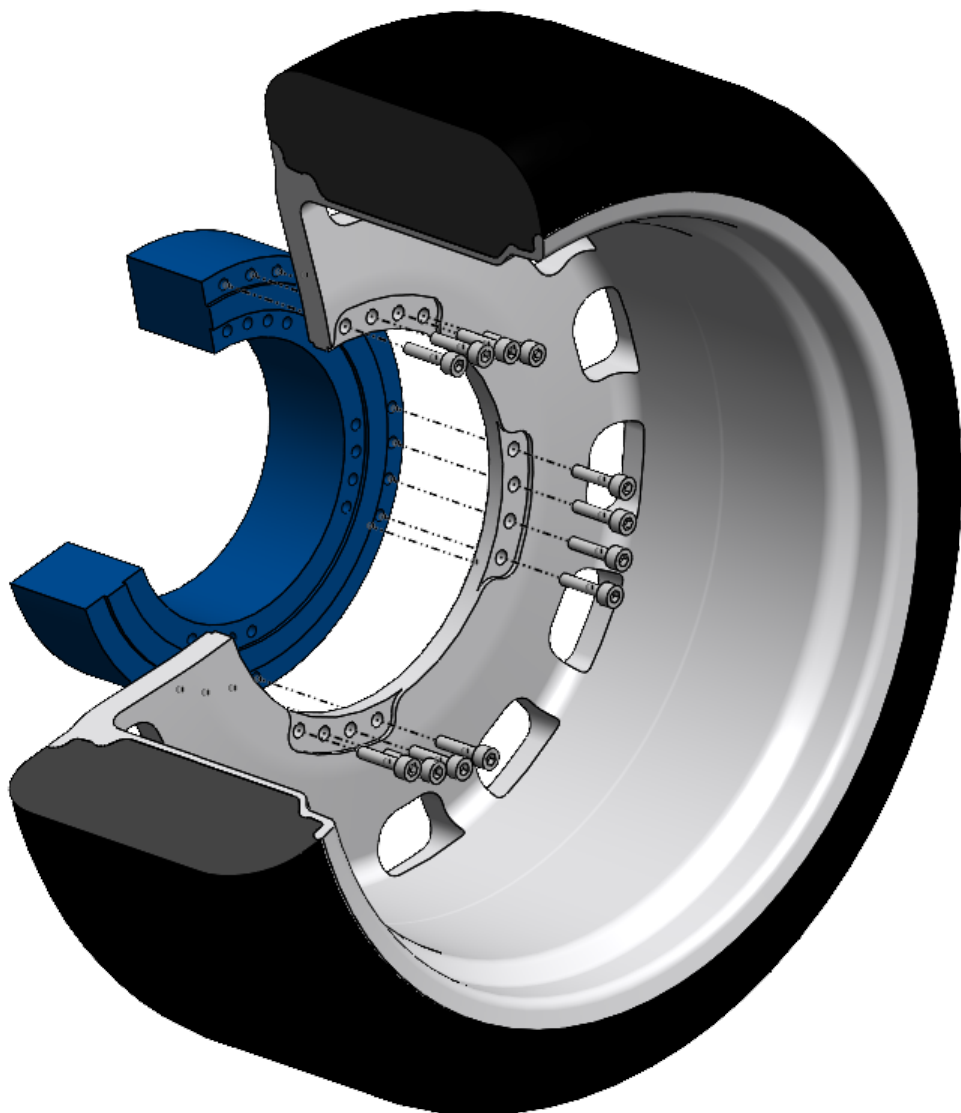

Fig. 16: Screw the modified rim (= external adaptor) to the WFT (blue).

Screwing of inner adaptor and WFT

Now screw the hub adaptor (= inner adaptor) to the WFT. It is mandatory to observe the current screwing instructions.

 Attention

Observe the screwing instructions

It is mandatory that the screws are attached in accordance with the **current screwing instructions**.

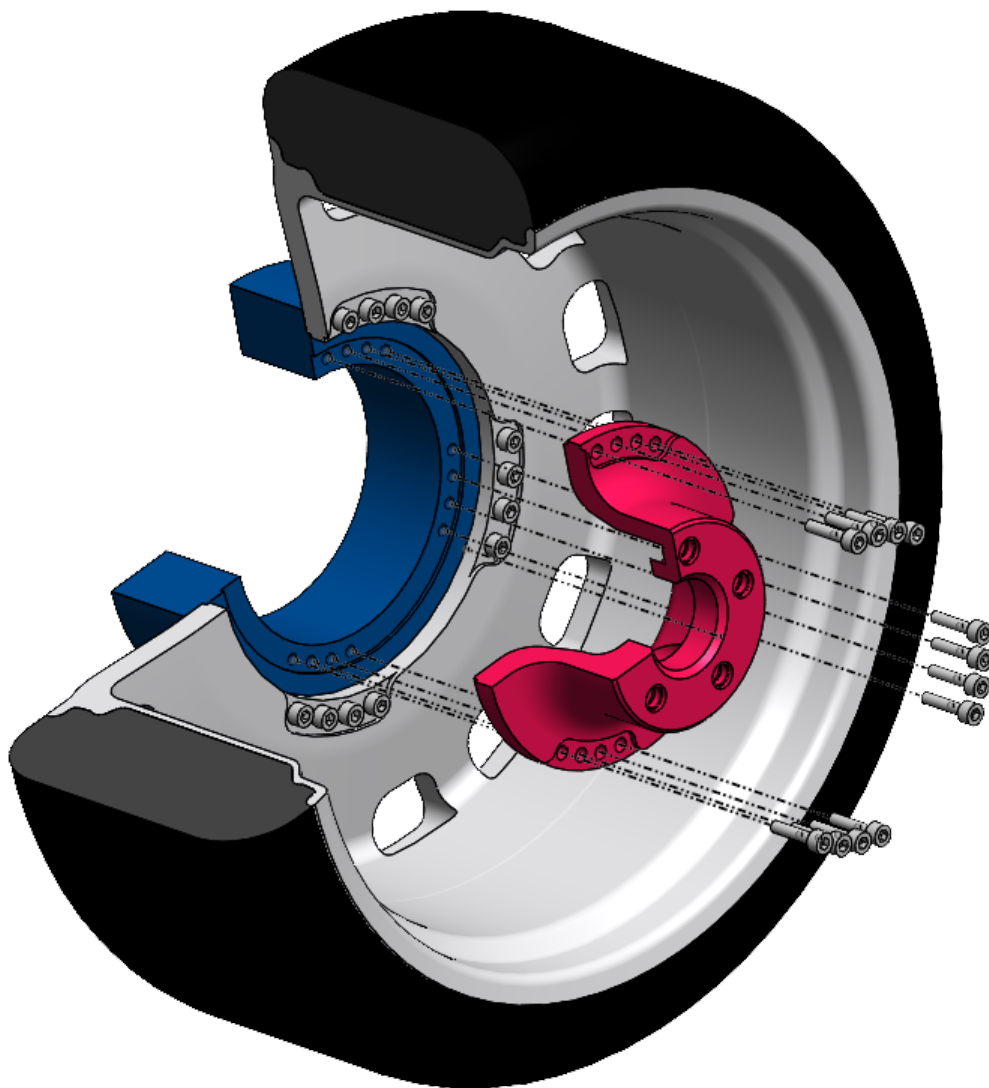

Fig. 17: Screw the hub adaptor (= inner adaptor; red) with the WFT (blue).

Wheel balancing

Now balance the wheel. Check first whether the balancing machine is suitable for wheel adaptation. Additional adapters may be necessary. For further questions, please contact the imc staff (hotline@imc-tm.de).

Prepare all desired wheels

Prepare all wheels that you want to equip with a WFT-C^x or -C^{xs} according to the points shown so far.

Wheel change

The measurement wheels can now be mounted on the vehicle.



Attention

Safety note: Tightening torque and screw type

The tightening torque and screw type must meet the manufacturer's specifications.

Mounting the rotary transmitter ("Y") to the WFT

Now mount the rotary transmitter ("Y") to the WFT.



Attention

Torque

Attention:

Use a torque of 5 Nm when mounting the rotary transmitter ("Y") to the WFT.



Warning

Rotary transmitter

The WFT is only sealed with a screwed rotary transmitter and inserted O-ring.

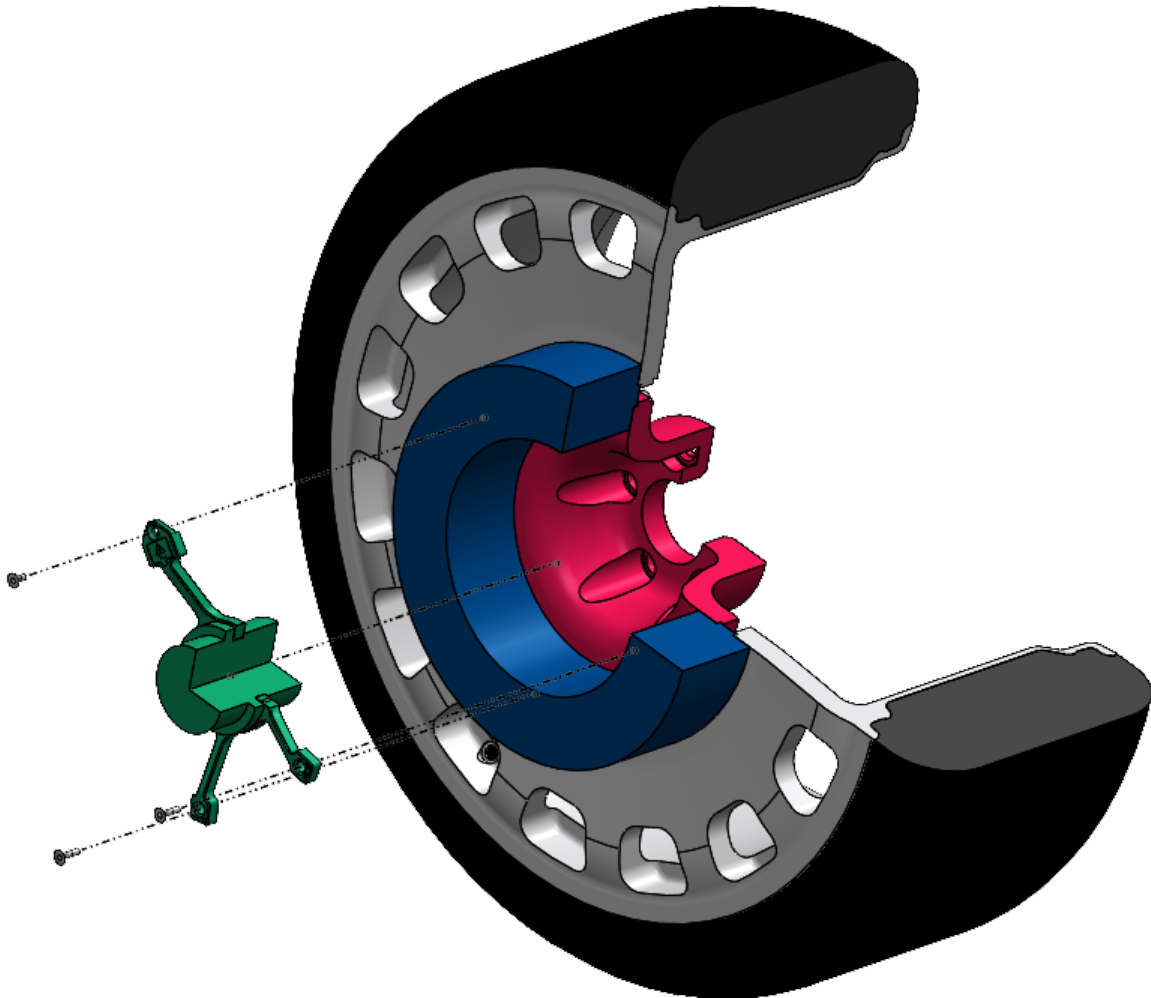

Fig. 18: Screw the rotary transmitter ("Y", green) to the WFT (blue).



Attention

Torque

Attention:

Use a torque of 5 Nm when mounting the rotary transmitter ("Y") to the WFT.

! Warning

Rotary transmitter

The WFT is only sealed with a screwed rotary transmitter and inserted O-ring.

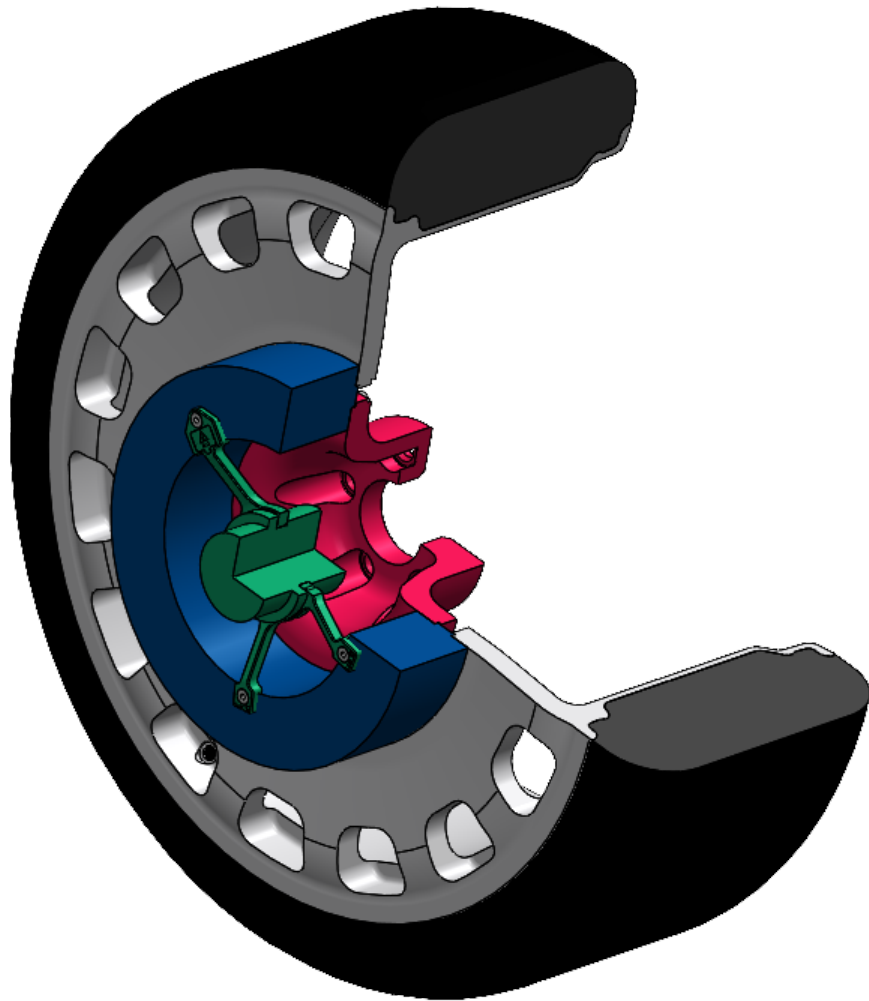

Fig. 19: The mounted WFT (blue) with hub adaptor (red), rotary transmitter ("Y", green) and modified rim.

Mount stator connection

Mount the fork and mount the torque arm e.g. with suction cups (these are available at imc). Align the torque arm parallel to the spring travel.

For individual stator connections, especially for front wheels, please contact imc (hotline@imc-tm.de).

Warning**Stability of the stator mounting**

The stability of the stator connection is decisive for the accuracy of the angle measurement and for the overall accuracy of the measurement data!



Fig. 20: Stator connection to the WFT, rear wheel (example photo)

Warning**Stabilität der Statoranbringung**

The stability of the stator connection is decisive for the accuracy of the angle measurement and for the overall accuracy of the measurement data!



Fig. 21: Stator connection to the WFT, front wheel (example photo)

Connect and place WFT connection cable

Connect the WFT connection cable and place it along the torque arm. Leave the cable enough clearance to compensate for the spring deflection.

Warning

Connecting or disconnecting the sensor data cable

When plugging or unplugging the sensor data cable, it is imperative to ensure that no moisture or dirt can affect the LEMO plugs.

Note

Sealing

The plugs are only waterproof when plugged in.



Fig. 22: i8 with WFT-C^x mounted on front and rear wheel

Check for clearance

Estimate the spring travel and check the torque arm for clearance to the sensor and vehicle parts. Please make sure that there is no pull on the cable during all driving maneuvers later on - including all up/down and lateral movements.

8.2 CRFX/WFT-2 Hardware Setup

1. Plug the sensor cable of the WFT-C^x or of the -C^{xs} to the respective CRFX/WFT-2 TTI input.

Sensor cable		article no.
H-CAB-LEM-WFT-6m	Connection cable between Wheel Force Transducer and CRFX module, cable length 6 m	13700012
H-CAB-LEM-WFT-12m	Connection cable between Wheel Force Transducer and CRFX module, cable length 12 m	13700013

LEMO pin configuration (H-CAB-LEM-WFT-6m, H-CAB-LEM-WFT-12m):

Pin	Signal
1	Command OUT
2	12 V POWER
3	Data OUT (normal)
4	Data OUT (invers)
5, 6	GND

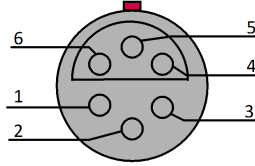

View on the plug

With one CRFX/WFT-2 module, up to two WFT-C^x or -C^{xs} sensors can be connected. Connect the left side WFT to the WFT-Input left input and the right side WFT to the WFT-Input right input. The WFT-C^x respectively the -C^{xs} are supplied with power via the sensor cable.

2. Connect the imc CRONOSflex (CRFX) to the imc STUDIO PC via an Ethernet cable.
3. Ensure that all components are activated and turn each WFT-C^x or -C^{xs} for at least one full revolution to hit the reference mark of the incremental angle encoder (mobile measurements only).

8.3 Configuration with imc STUDIO

- Ensure that the [installation of the sensor](#)³² has been performed correctly.
- Connect the WFT with the [CRFX system](#)⁴⁴ and ascertain that all components have been activated.

Importing parameters from the sensor

Upon first connecting with the sensor, all relevant settings are imported from the sensor. E.g. the measurement ranges are set appropriately to no longer require adjustment. If any change to the sensor is detected (the serial number is changed), then upon connection, the parameters are re-imported. The currently applicable configuration is overwritten.

Global settings

The sampling rate and filter settings apply jointly to all channels on the same terminal.

8.3.1 Channels and parameters

Channels whose data are transmitted from the sensor (separately for the left and right wheels). The signals are managed as analog channels and are included in the calculation of the maximum number per device.

Channels	Unit	Associated parameter
Status_*		State-flag ⁴⁶⁾
Fx_*	kN	Range, Fx/Fz
Mx_*	Nm	Range, Mx/Mz
Fy_*	kN	Range, Fy Offset of "TTI" determined during balancing
My_*	Nm	Range, My Offset of "TTI" determined during balancing
Fz_*	kN	Range, Fx/Fz
Mz_*	Nm	Range, Mx/Mz
Umdr_* (revolutions)		Range: [-32768; 32737]; Number of revolutions of the WFT
Drehz_* (RPM)	RPM	Range: [-3061.224; 3061.131]; current speed of the WFT; results from internal calculations of the TTI
Temp_* (Temperature)	°C	Range: [-128.0000; 127.9961]; Temperature of WFT
Aux_* (Auxiliary -inputs)	mV/V	Range, Aux Offset of "TTI" determined during balancing
rot_fx_*; Fx (rotating coordinate system)	kN	Range, Fx/Fz Offset of "TTI" determined during balancing
rot_mx_*; Mx (rotating coordinate system):	Nm	Range, Mx/Mz Offset of "TTI" determined during balancing
rot_fz_*; Fz (rotating coordinate system)	kN	Range, Fx/Fz Offset of "TTI" determined during balancing
rot_mz_*; Mz (rotating coordinate system)	Nm	Range, Mx/Mz Offset of "TTI" determined during balancing
Angle_*	°	Range: [-180.0000°; 179.9945°]. Spirit level default = 0° Angle offset
Sin_* (Angle, Sine)		Range: [-1.000000; 0.999969]; Default= 0
Cos_* (Angle, Cosine)		Range: [-1.000000; 0.999969]; Default = 0999969

Status-Flags

Bit	State-Code	Description (bit active/passive)
2 ⁰	1	WFT detected / not detected
2 ¹	2	not yet activated; always 1
2 ²	4	Offset-balancing running / not running
2 ³	8	Shunt active/passive
2 ⁴	16	Remote active/passive
2 ⁵	32	Spirit level mode active/passive
2 ¹⁵	32768	Error / no error

The status channel can be displayed in the STUDIO panel with a DIO widget. This allows the states of the individual bits to be read directly.

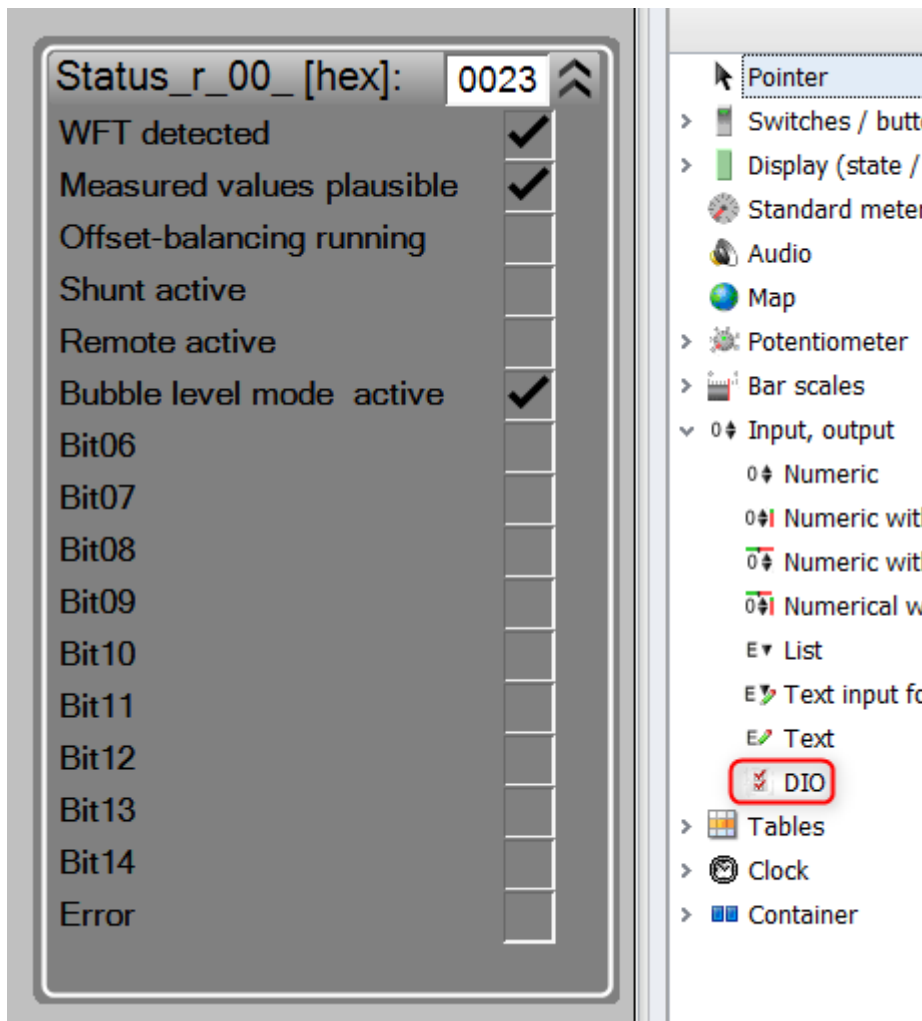

Fig. 23: status channel in imc STUDIO

LED-Status

Active channels

LED indicator	State-Code	Description
red continuously	0	WFT not detected
green continuously	3 (=1+2)	WFT detected / Measured values plausible
green 5 Hz	5 (=1+4)	Offset-balancing running
green 0.5 Hz	35 (=1+2+32)	Spirit level mode active WFT detected / Measured values plausible
red/green 1Hz	1	WFT detected / Measured values not plausible
red 5 Hz	32768	error

Passive channels

LED indicator	Status-Code	Description
off	0	WFT not detected
yellow continuously	2 (=1+2)	WFT detected
red 5 Hz	32768 (=1+4)	error

8.3.2 Preparing and performing measurement

The measurement ranges are fixed and would only be changed if the measurement wheel type was changed. The wheel itself provides the system with its associated ranges and scaling.

The following steps must be performed in order to prepare for measurement:

- [Importing the WFT info](#)^[49]
- [Angle alignment](#)^[49]
- [Zero Balance](#)^[53]
- Compensation of the [axial](#)^[58] and [radial offsets](#)^[58]

8.3.2.1 Importing the WFT data

All info characterizing the measurement wheel, including the channel info, is first imported.

To do this, go to the page *Analog Channels* and click on the button "Read sensor information".

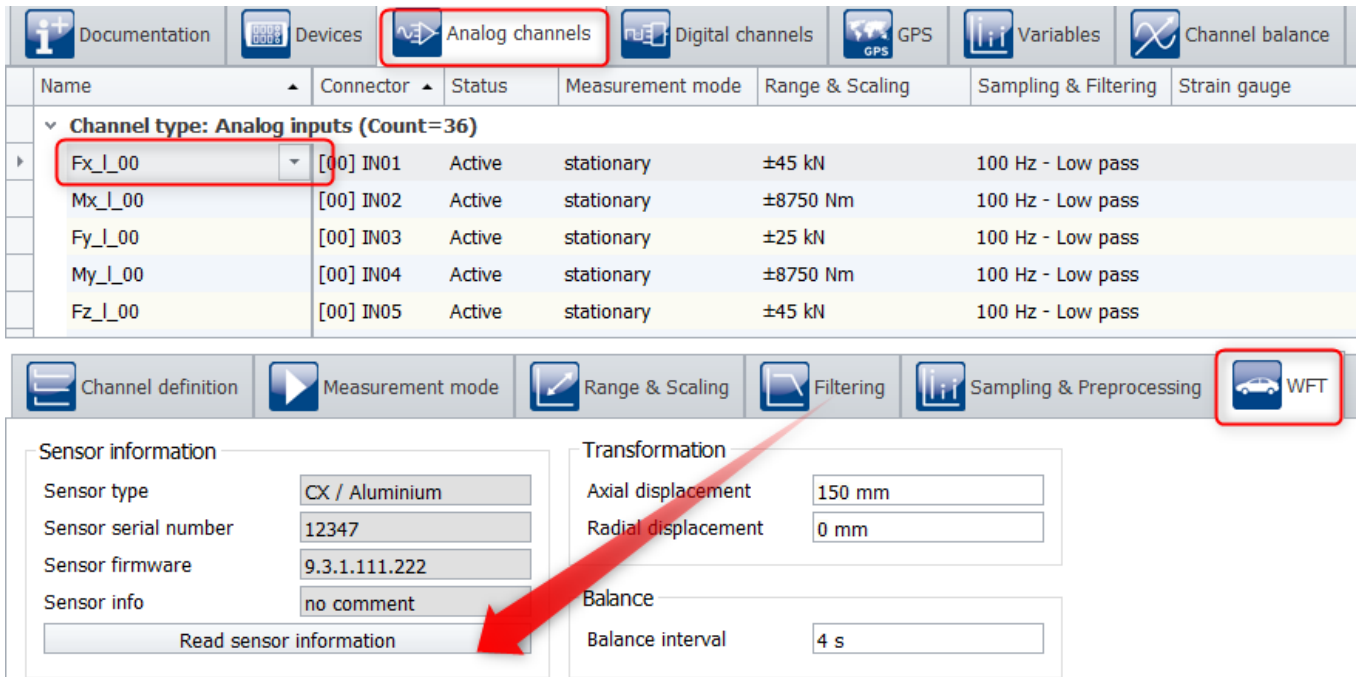

Fig. 24: Importing info from the WFT

All of the WFT's information is imported. It is not necessary to select each channel individually.

8.3.3 Angle Alignment

After installation of the WFT-C^x or -C^{xs}, the angle signal has to be aligned for each WFT-C^x and -C^{xs} sensor. For this procedure the vehicle must be located at a horizontal and smooth surface. If a lifting platform is to be used, make sure that the vehicle is aligned around the longitudinal and transverse axes.

Note Valid Angle Signal

Before starting the angle alignment procedure, each WFT-C^x and -C^{xs} has to be turned for at least one complete revolution to hit the reference mark of the incremental angle encoder. Not until then a valid angle signal is available.

8.3.3.1 Automatic Angle Alignment (Spirit Level)

Note

This function is only available with the mobile operating modes [mobile \(rotary\)](#) or [mobile \(stationary\)](#). The angle alignment is performed at the stationary vehicle.

- Turn each WFT-C^x or -C^{xs} for at least one complete revolution to hit the reference mark of the incremental angle encoder. Not until then a valid angle signal is available.
- The vehicle must be located at a horizontal and smooth surface. Make sure there are no interfering forces exerted at the sensor during the alignment process. When testing the measuring wheel without the vehicle, make sure that the measuring wheel is adjusted in the upright position as if it were attached to the vehicle.
- Open the angle channel of the respective WFT-C^x or -C^{xs} in the *STUDIO Setup* on page *Analog channels*. E.g., select the channel *angle_r_xx* for the wheel force transducer connected to the TTI input WFT-In2 (right) of the CRFX/WFT-2.
- Set the *Coupling* for the angle channel to *Spirit level*.

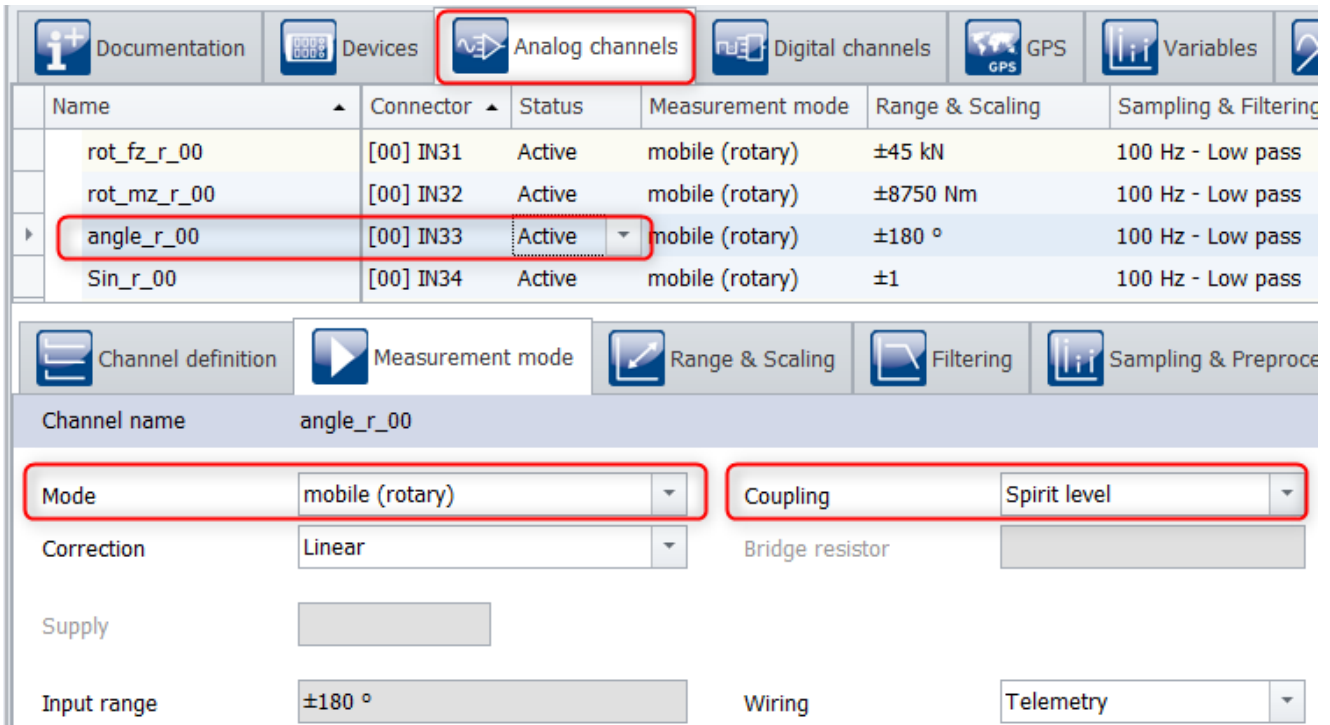

Fig. 25: Automatical angle alignment: Coupling of spirit level

- Go to the page *Channel balance* and click on the button "Spirit level".
The deviation is measured and saved in the module.

Channel name	Connector	Balance status	Balance action	Balance compensation	Balance
RPM_l_00	[00] IN08				
Temp_l_00	[00] IN09				
Aux_l_00	[00] IN10	bridge balancing OK	Bridge	0 mV/V; 0 mV/V	21.06.20
rot_fx_l_00	[00] IN11	Zero adjustment OK	Zero adjustment	0 N; 0 N	25.06.20
rot_mx_l_00	[00] IN12	Zero adjustment OK	Zero adjustment	0 Nm; 0 Nm	25.06.20
rot_fz_l_00	[00] IN13	Zero adjustment OK	Zero adjustment	0 N; 0 N	25.06.20
rot_mz_l_00	[00] IN14	Zero adjustment OK	Zero adjustment	0 Nm; 0 Nm	25.06.20
angle_l_00	[00] IN15	not balanced	Spirit level	3.21 °;	
Sin_l_00	[00] IN16				

Fig. 26: Perform angle alignment

Important:

For the next steps, the setting for the *Coupling* on the page "Analog channels" must be restored to *TTI*.

Name	Connector	Status	Measurement mode	Range & Scaling	Sampling & Filtering
rot_mz_r_00	[00] IN32	Active	mobile (rotary)	±8750 Nm	100 Hz - Low pass
angle_r_00	[00] IN33	Active	mobile (rotary)	±180 °	100 Hz - Low pass

Channel name	Mode	Coupling
angle_r_00	mobile (rotary)	TTI

Fig. 27: Next, set the coupling back to TTI

8.3.3.2 Manual Angle Alignment (Spirit Level)

- Turn the WFT-C^x or -C^{xs} to the 0° position (Fz mark at the sensor shows up).
- Open the angle channel of the respective WFT-C^x or -C^{xs} in the dialog *Chanel balance*.
- Control the 0° position of the WFT-C^x or -C^{xs} with a spirit level.



Fig. 28: Measuring with the bubble level

Note

Please Note

The angle alignment procedure is performed at the **stationary vehicle**.

- After the preparation process, the angle value measured appears in the column of instantaneous values. Alternatively, start the measurement and open a curve window for the angle channel by double-clicking on the head of the row. Set the window to "Last value as number" and configure the calculated display by double-clicking on the number with *Average of last values across 1000 values*, for instance.

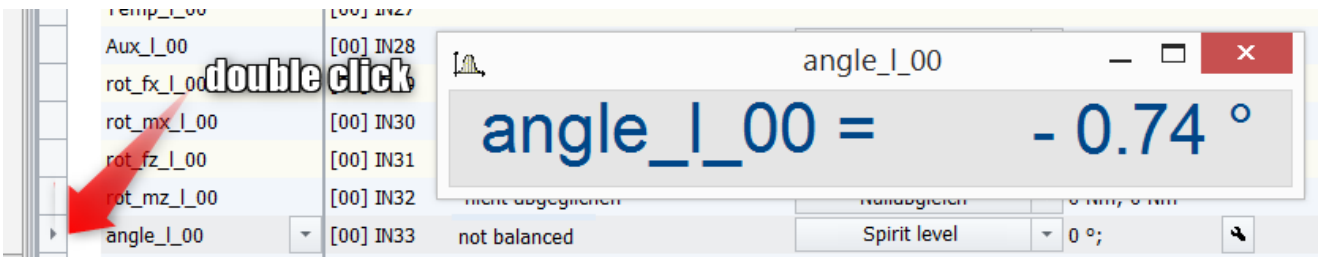

Fig. 29: Manual angle adjustment: Measuring actual values

- Enter the value manually in the column *Balance compensation*:

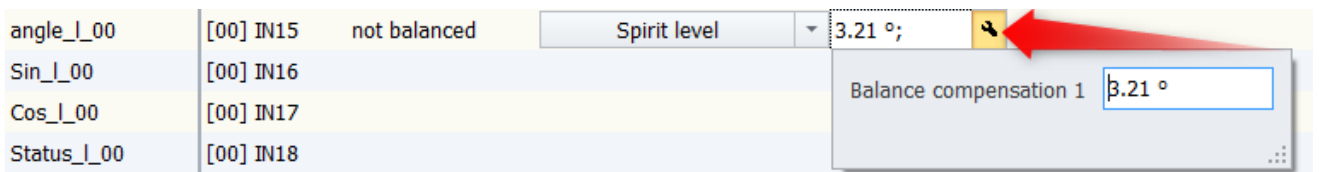

Fig. 30: Manual angle adjustment: Entering the offset

**Note****Balance status: not balanced**

The "*Balancing status*" remained "*not balanced*" because no automatic balancing had been performed. However, the manually entered value is used.

8.3.4 Zero Balance

After coordinate transformation from the rotating to the stationary coordinate system, offset errors appear as a periodic interference signal. It is therefore necessary to reduce all zero offsets to a minimum. The zero offset is stored permanently within the WFT-C^x or -C^{xs} electronics.

Before zero balancing, an angle alignment has to be performed for all rotational applications:

- [Automatic Angle Alignment \(Spirit Level\)](#) ⁴⁹
- [Manual Angle Alignment \(Spirit Level\)](#) ⁵¹

Note

Accurate zero balancing is crucial for precise WFT-C^x and -C^{xs} measurements, as each error in zero balancing causes a systematic error in the measurement data.

Balance interval/-duration

Balance interval is used as:

- **Averaging duration** for [stationary zero balancing](#) ⁵⁶, where the entire time duration until the balanced value is adopted is more than three times as long. The **duration** of the adjustment is the same for all channels and is set on the page "WFT" under *Analog channels*. For this purpose, a channel which is able to be balanced must be selected.

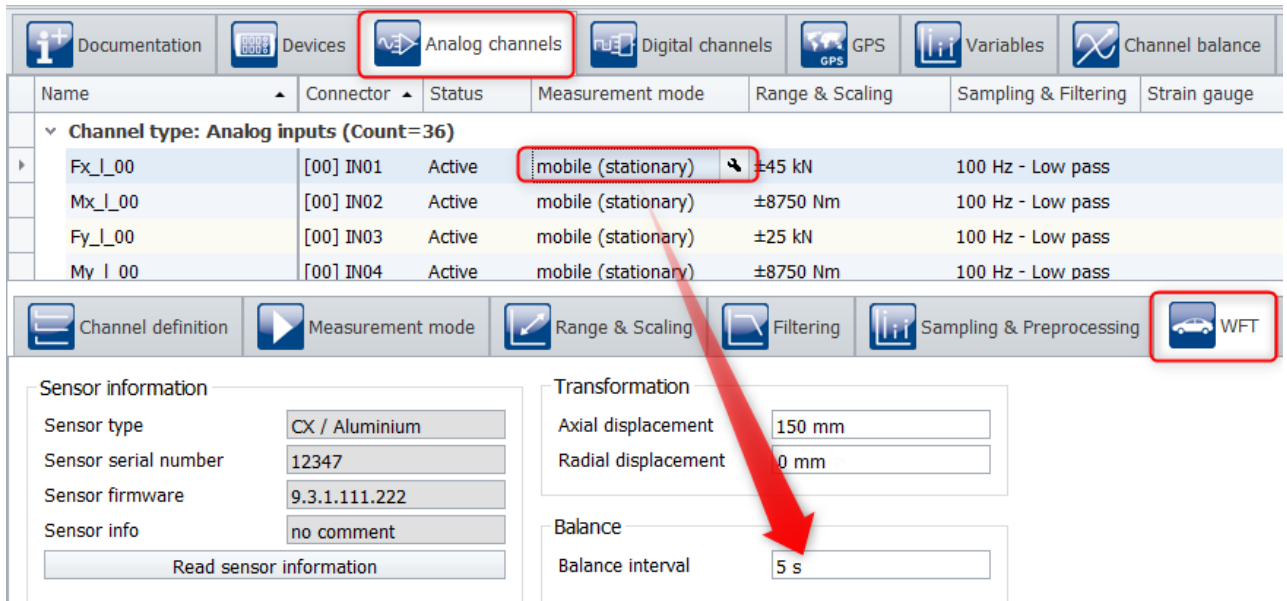

Fig. 31: Duration for stationary zero balance

- **Count** of revolutions for [rotary balancing](#)⁵⁵. For a complete adjustment, the entered number of revolutions is run through three times.

Fx_I_00	[00] IN01	Active	mobile (rotary)	±45 kN	100 Hz - Low pass
Mx_I_00	[00] IN02	Active	mobile (rotary)	±8750 Nm	100 Hz - Low pass
Fy_I_00	[00] IN03	Active	mobile (rotary)	±25 kN	100 Hz - Low pass
My_I_00	[00] IN04	Active	mobile (rotary)	±8750 Nm	100 Hz - Low pass

Channel definition
Measurement mode
Range & Scaling
Filtering
Sampling & Preprocessing
WFT

Sensor information

Sensor type:

Sensor serial number:

Sensor firmware:

Sensor info:

Transformation

Axial displacement:

Radial displacement:

Balance

Balance interval:

Fig. 32: Number of revolutions for rotary adjustment

8.3.4.1 Operating Mode "mobile (rotary)"

With this zero balance mode, forces and torques are balanced during a number "x" of revolutions. The vehicle's weight g_0 plays a role as a component of F_z ; conversely g_0 has no influence on F_x or F_z in angle alignment.

For this type of zero adjustment a horizontal and smooth surface is required.

- Open a force or torque channel (vehicle coordinate system) of the respective WFT-C^x or -C^{xs} or sensor on page "Analog channels", e.g. channel $F_x_I_xx$ for the wheel force transducer connected to the TTI input "WFT- In1 (left)" at the CRFX/WFT-2.
- Select *mobile (rotary)* adjustment in *Measurement mode*.

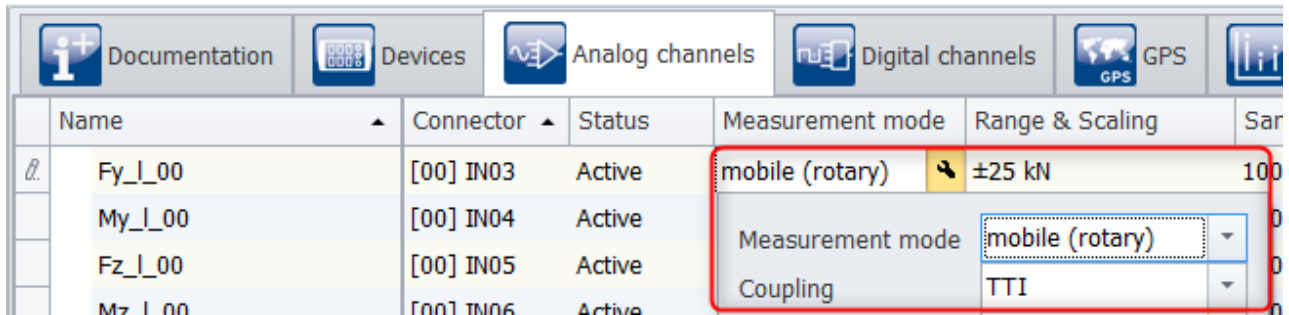

Fig. 33: Measurement mode "mobile (rotary)"

- Set the vehicle in motion. While the zero adjustment process is running, the vehicle should roll out. When rolling out, pay attention to the following:
 - do not depress the brake pedal
 - do not accelerate
 - set the automatic system to "Neutral"
 - drive in a straight line
 - drive on a horizontal and even surface.

Set the count of revolutions here: [Balance interval/duration](#) ⁵³

- To start the offset compensation routine, click on "Zero-adjustment" on page "Channel balance"

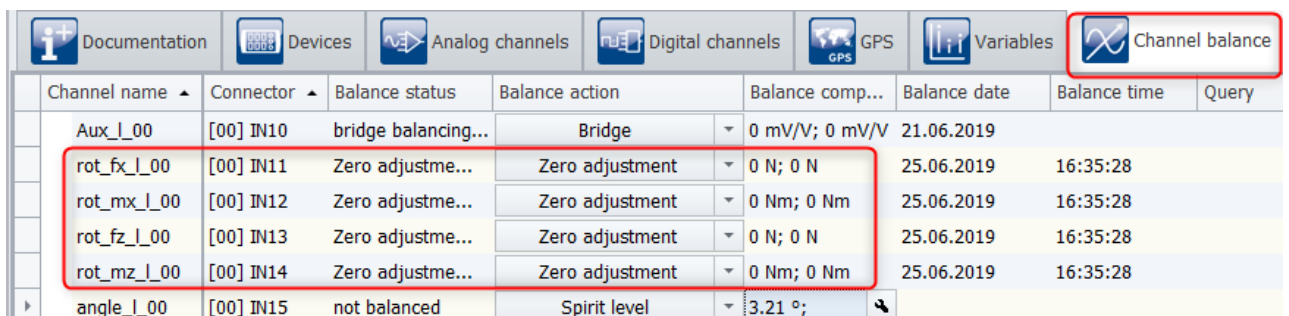

Fig. 34: Measurement mode "mobile (rotary)": perform zero adjustment

8.3.4.2 Operating Mode "mobile (stationary)"

For a rotating zero adjustment, you need a flat road of sufficient length. If this is not available, the rotating zero adjustment cannot be performed with the desired accuracy. In this case, a stationary zero adjustment can be performed at two angle positions.

In this case as well, the vehicle's weight g_0 plays a role as a component of F_z ; conversely g_0 has no influence on F_x or F_y in angle adjustments.

- Turn the WFT-C^x or the -C^{xs} sensor to the 0° position. Here, the F_z mark shows up. Check the 0° position with a water level. The deviation from 0° is to be < ±5°.
- Select the F_x channel on page "Analog channels", e.g. channel $F_x_l_xx$ for the wheel force transducer connected to the TTI input "WFT- In1 (left)" at the CRFX/WFT-2.
- Select *mobile (stationary)* adjustment in *Measurement mode*.

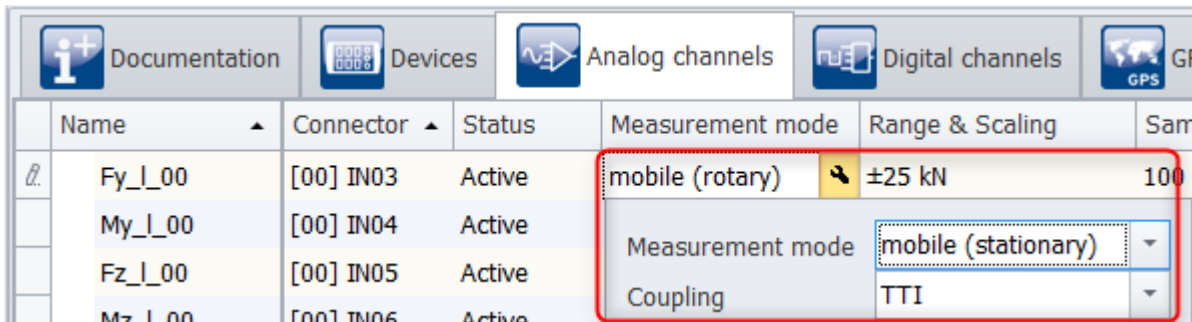

Fig. 35: Measurement mode "mobile (stationary)"

- Make sure the vehicle stands still and there are no external forces/torques on the components to be compensated.
- To start the offset compensation routine, click on "Zero-adjustment" on page "Channel balance"

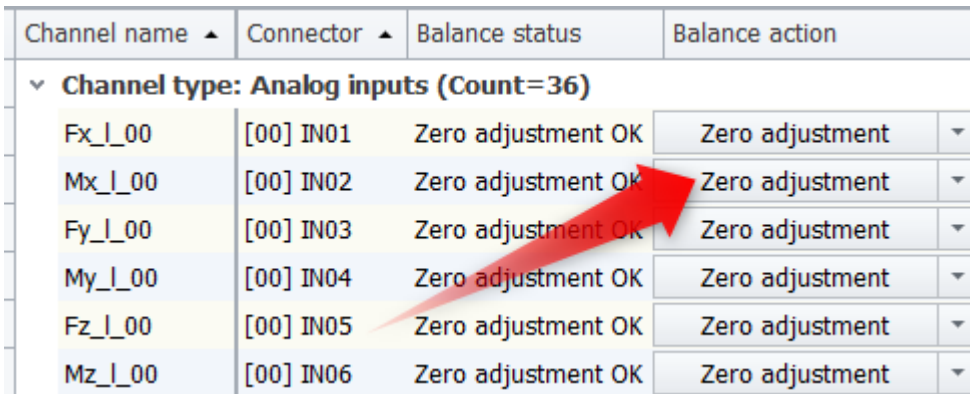

Fig. 36: Measurement mode "mobile (stationary)": Perform zero adjustment

- Turn the WFT-C^x or the -C^{xs} to the 90° position. In this position, the F_z mark shows backwards, opposite to the direction of travel. Check the 90° position with a spirit level. Its deviation needs to be < ±5°.
- Make sure the vehicle stands still and there are no external forces/moments on the components to be compensated.
- To start the offset compensation routine, click on "Zero-adjustment" on page "Channel balance"

8.3.4.3 Operating Mode "stationary"

With this zero adjustment routine, all forces and torques exerted on the sensor at the time of the adjustment are zeroed. This includes canceling out the mean weight of the vehicle.

- Open a force or torque channel (vehicle coordinate system) of the respective WFT-C^x or the -C^{xs} sensor on page "*Analog channels*", e.g. channel *Fx_l_xx* for the wheel force transducer connected to the TTI input "*WFT- In1 (left)*" at the CRFX/WFT-2.
- Select *stationary* in *Measurement mode*.
- Make sure the vehicle stands still and there are no external forces/torques while the zero adjustment is in process.
- To start the offset compensation routine, click on "*Zero-adjustment*" on page "*Channel balance*".

8.3.5 Compensation "Axial/Radial displacement"

Axial displacement

- Open the F_x channel of the respective WFT-C^x or the -C^{xs} sensor on page "Analog channels", e.g. channel F_x / I_{xx} for the wheel force transducer connected to the TTI input "WFT- In1 (left)" at the [CRFX/WFT-2](#)
- Select the page *WFT* and enter the **Axial displacement** in mm in the input box (1):

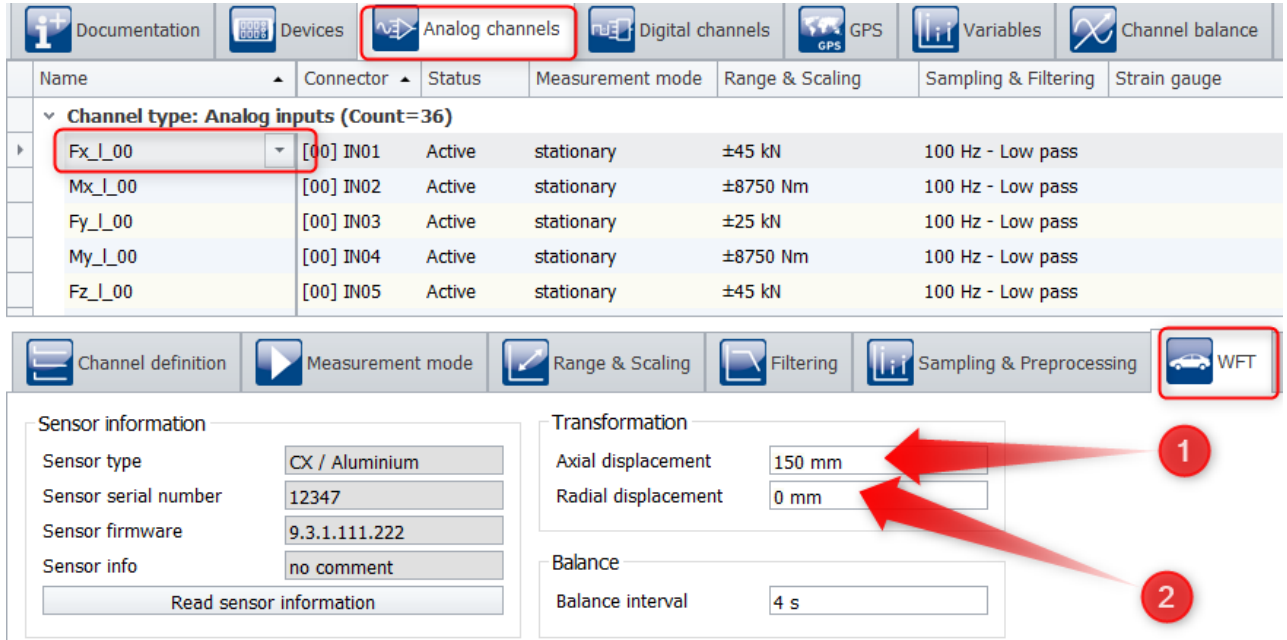

Fig. 37: Entering: Axial and radial offset

Reference

Further information on "[Axial displacement](#)"

Radial displacement

- Open a force or torque channel (vehicle coordinate system) of the respective WFT-C^x or the -C^{xs} sensor on page "Analog channels", e.g. channel F_x / I_{xx} for the wheel force transducer connected to the TTI input "WFT- In1 (left)" at the CRFX/WFT-2.
- Select the page *WFT* and enter the **radial offset** in mm in the input box (2).

Reference

Further information on "[Radial displacement](#)"

8.4 imc WFT Assistant



The WFT-Plug-in provides a convenient Assistant for configuration of wheel force transducers, plus pre-made Panel pages designed for optimal display of measurement results.

Prerequisites:

- Device software: imc STUDIO 5.2 R25
- The "imc WFT Assistant" is activated in the "Product configurator".
- Only one device may be selected for measurement.
- The base unit **CRFX-2000GP** is supported (**recommended: CRFX-2000GP-WFT**) with at least one WFT-2 module.
- When using remote control:
 - The **CRFX-2000GP-WFT** base unit is required. This special base unit includes a terminal for remote control.
 - Remote control requires 1 DIIn-bit and 4 DOut-bits. For this purpose, the last bits of the respective port are reserved. They may not be utilized for any other purpose.
 - The control commands in imc Online FAMOS must be activated.
 - Timer 8 may not be in use.
- During configuration, the connection with the device must be active; no measurement may be running.

Opening the Assistant

Select the item "WFT" in the menu ribbon. The WFT Assistant is then displayed in a dialog.

Ribbon	View
Start > WFT 	all
Setup-configuration > WFT 	Complete

Menu item: WFT Load

- loads the previous configuration, if applicable
- checks whether any WFT-sensors are connected

When there are more than two WFT-2 modules, the first two module-IDs are always used.

The parameter "Status" lists the respective results.

Status	Color	Description
Active	green	sensor recognized <ul style="list-style-type: none"> • all channels are active and • all channel names match the prefix/postfix-pattern ⁶⁰
Connected	yellow	sensor recognized <ul style="list-style-type: none"> • not all channels are active, or • at least one channel name does not match the prefix/postfix-pattern ⁶⁰, or • the serial number does not match that of the last one connected
Missing	red	sensor missing
Passive	transparent	no sensor recognized

Note**A different WFT-sensor is connected**

When the WFT-sensor is connected, if its serial number does not match the serial number of the sensor, this sensor is displayed as "connected". Additionally, the serial number of the previously connected WFT-sensor is listed.

When the sensor information is imported, the serial number in the experiment is updated so that in consequence, updating the configuration again causes the serial number to no longer be displayed!

Rename channels - Prefix/postfix-pattern

A WFT-sensor's channels can be renamed to feature a prefix before and a postfix after the specified middle portion of the name. Empty elements are allowed, as long as all WFT-sensors each have different names. Any changes to the channel names are highlighted in yellow.

Notes**Renaming via the Channels table not recommended**

Changing the channel names in the Channels table is not recommended. The changes will be reversed upon the next call of the WFT-Assistant. Ideally you would use the prefix and postfix in order to be able to jointly modify the channel names of associated channels.

Positioning modules/sensors and modifying the axis configuration

Positioning of the WFT-modules and sensors is performed by means of the buttons in the middle of the Assistant.

Two WFT-modules

When using **two WFT-modules**, it is only possible to switch the assignment from front to back. A module having two sensors is always assigned to an axis.

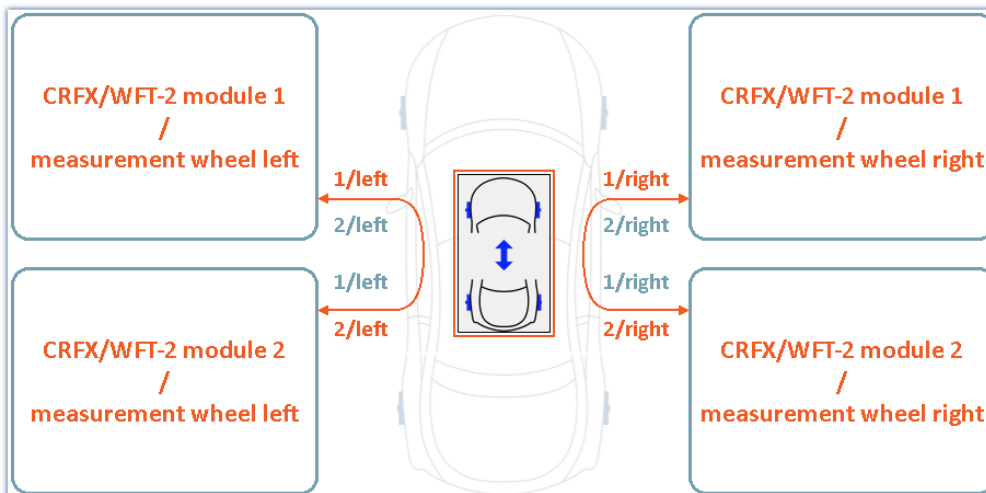

Two CRFX/WFT-2 modules, each with two wheel force transducers

One WFT-module

When using **one WFT-module**, the two sensors can be positioned in front, back, right or left.

When only one CRFX/WFT-2 module and a single-sided configuration (left/right side of vehicle) is used, the system automatically makes an internal correction to apply the reversal of the WFT's coordinate system to the new wheel position. For a configuration for the left vehicle side, the right-side sensor is corrected, and for a configuration for the right vehicle side, the left-side sensor is corrected.

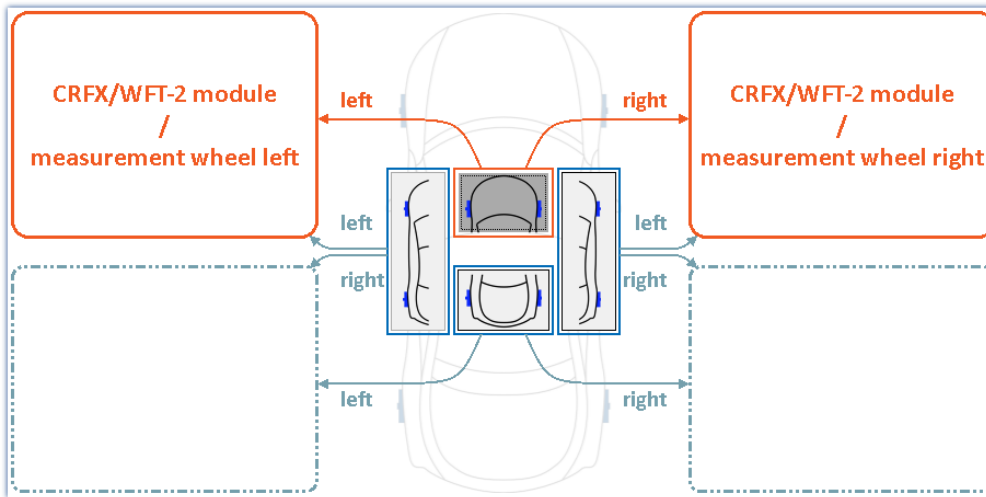

One CRFX/WFT-2 module with two wheel force transducers

Correction of names upon change of axis assignment

When the axis assignment is changed in this way, the following actions are performed automatically:

- Default postfix names are automatically modified. For instance, if the sensor is now located at "rear left", then "_fl" (front left) is automatically changed to "_rl".
 - Any manually modified postfix names remain unchanged. The channel names "migrate" with the axis assignment.
- Any manual changes to the channel names via the Channels table are reset (see notes on "[Renaming via Channels table](#)").
- Any missing or wrong names are replaced with the default names (e.g. "WFT_", "_fl").

Menu item: Apply Setup

Various actions are performed when the item "Apply Setup" is selected. The system checks the configuration and applies it in accordance with the "Status". The channels' names are set, and the actions for angle compensation are enabled. Closing options (Panel/Remote Control) can now also be enabled.

Status	Actions which depend on the Status	Additional actions
Active	all of the sensor's channels 1. are renamed, as defined by the prefix and postfix and	3. if applicable, modification of the algebraic sign in case of single-sided configuration with only one WFT-2 module
Connected	2. are activated	4. channel parameter "Balance at device startup" is deactivated 5. imc Online FAMOS source text of the remote control is deleted (see explanation regarding imc Online FAMOS)
Missing	all of the sensor's channels 1. are reset to their default names	
Passive	2. are deactivated (passive)	6. if appropriate, the Digital-In/Out-bits used are reset to their default names



Notes

Re-activating remote control

When remote control is used, it must be re-activated before closing the Assistant.

Menu item: Show Angle

The angles of the individual wheel force transducers are displayed. It is possible to check the position and, if appropriate, to adjust it.

- The button is active as soon as the current configuration is loaded.
- Only WFT-sensors having the Status "Active" are displayed. If necessary, first run the function "Apply Setup".

Menu item: Angular Zero

The spirit level angle adjustment is started. The Assistant guides you through the necessary steps. Once adjustment of the angle has been performed successfully, the display of the wheel force transducers should match the alignment of the wheel force transducers to the vehicle.



Reference

Spirit level angle adjustment

More information on the spirit level angle adjustment is presented in the WFT manual.

Axial displacement

The wheel force transducer is not mounted axially in the center of the vehicle wheel, in consequence of which there is an offset along the wheel's axis (see graphic for axial displacement). Since the forces are exerted orthogonally to this axis, torque effects result in the x- and z-planes in proportion to the offset. If the offset is known, the software can compensate for the discrepancies.

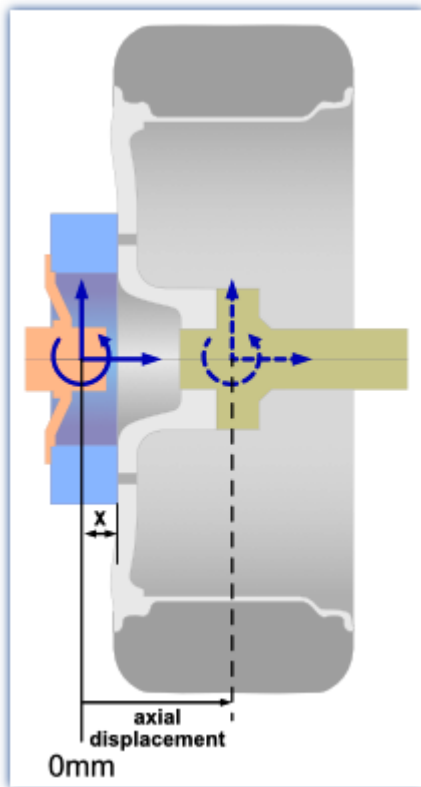

Axial displacement

In order to apply a calculated shift of the coordinate system along the axis, follow the instructions in the dialog for the axial offset.

Menu item: Close

This performs concluding actions and closes the Assistant. There are two options for closing the Assistant: "*Remote Control*" and "*Panels*"

With "*Remote Control*" option activated:

- Activates the Remote Control (imc Online FAMOS-source text is integrated into the existing text - see explanations regarding [imc Online FAMOS](#)^[64]).
- The Digital-In/Out-bits are activated and renamed.
- The channel parameter "*Balance at device startup*" is activated for the active sensors.

With "*Panels*" option activated:

- The Panel pages are imported (and [overwritten if appropriate](#)^[64]).
- The channel names in the curve windows are modified according to the current configuration. Channels which are not active are deleted from the curve window.

Any curve windows which no longer contain channels once the channel names have been replaced are hidden. Any Panel pages which no longer have visible curve windows after replacement of the channel names are deleted.

Panel page

There are pre-configured Panel pages which are imported when the pertinent option offered upon closing the Assistant is activated. These Panel pages are located in the following folder:

```
"C:\Users\Public\Documents\imc\imc STUDIO\WFT"
```

The pages are named according to the following pattern: "WFT_WIDGET_*.dbv". If no pages exist there yet, they will be newly created there by the WFT-Assistant.



Notes

Pages with "WFT_WIDGET_" in their name will be overwritten

Upon importing, any Panel pages having the same internal "Name" (not the same "Title") as one of the pages to be imported are deleted without any warning message and replaced with the new page. If you do not intend for the pages generated by the WFT-Assistant to be deleted, the internal "Name" of the page must be changed. The WFT-Assistant does not change or delete any pages which do not match the name pattern.

Changing the templates

The Panel page templates can be modified and changed in accordance with your personal wishes. During import, the channels in the curve windows are assimilated to the current names of the channels. For this purpose, the names specified must adhere to the following pattern:

```
"WFT_WIDGET_*_FL", "WFT_WIDGET_*_FR", "WFT_WIDGET_*_RL", "WFT_WIDGET_*_RR"
```

The asterisk * stands for the channel name in English (e.g. "Angle", "RPM", "Revs"). Important! Only the channels in the **curve windows** are replaced by the WFT-Assistant! Other Widgets remain unaffected.

Deleting templates

Individual Panel-files can be deleted from the folder. They are then no longer imported by the WFT-Assistant. Only once there is no longer any pertinent Panel-file present will the WFT-Assistant save the files in the folder again.

Preallocation of the Digital In/Out-bits

Remote control requires 1 DIIn-bit and 4 DOut-bits. For this purpose, the last bits of the respective port are allocated automatically. In order for the bits to be recognizable by the WFT-Assistant, they are renamed accordingly.

imc Online FAMOS

Some of the remote control options require their own imc Online FAMOS-source text. For this purpose, the existing imc Online FAMOS-source text is modified. The WFT-Assistant modifies only regions within the keywords `;WFT_WIDGET` and `;/WFT_WIDGET`. The other regions remain unchanged and can be used as accustomed. Only the "Timer (8)" is needed. This may not be used for other purposes.

The control commands are used and must be activated manually. In order for exchange of the source text to be possible, the control commands must be uniquely identifiable. For this reason, please do not insert any comments in the control command's keyword line. The source text elements are always inserted at the beginning of a control command by the WFT-Assistant. Any control commands which are not yet present are appended at the end.

The template for the imc Online FAMOS-source text is saved in the following folder:

```
"C:\Users\Public\Documents\imc\imc STUDIO\WFT"
```

The template may not be changed. If the file is missing, it is saved there again upon the next start of the WFT-Assistant. Additionally, all temporary files such as the exported and unmodified imc Online FAMOS-file are saved there.

9 Technical Specs

9.1 WFT sensors

Parameter	Value				Remarks
	WFT-C ^x			WFT-C ^{xs}	
Material	Aluminium	Titan	Steel	Aluminium	
Measurement principle	temperature compensated strain gauge application				
Measurement ranges					
Forces	$F_x, F_z = \pm 45 \text{ kN}$ $F_y = \pm 25 \text{ kN}$	$F_x, F_z = \pm 60 \text{ kN}$ $F_y = \pm 30 \text{ kN}$		$F_x, F_z = \pm 25 \text{ kN}$ $F_y = \pm 20 \text{ kN}$	
Torsional moment	$M_x, M_z = \pm 8.75 \text{ kNm}$ $M_y = \pm 8.75 \text{ kNm}$	$M_x, M_z = \pm 10 \text{ kNm}$ $M_y = \pm 10 \text{ kNm}$		$M_x, M_z = \pm 6 \text{ kNm}$ $M_y = \pm 6 \text{ kNm}$	
Sampling rate	up to 10 kHz				per channel with CRFX/WFT-2 module
Angle resolution	0.072 °				5000 increments
Accuracy	<0.2 %				of the measured value
Hysteresis	<0.2 %				of the range
Crosstalk	<0.2 %				of the measured value
Temperature drift	0.005 %/°C				
Low pass filter	6-pol Butterworthfilter				cut-off frequency: 1200 Hz
Revolution speed	max. 2300 rpm (approx. 278 km/h)				
Weight	approx. 7.5 kg	approx. 10.5 kg	approx. 17.5 kg	approx. 5.9 kg	w/o adapters
Dimension (w/o adapter)	317.5 mm 203.0 mm 76.0 mm			61.5 mm	outer diameter (OD) inner diameter (ID) height
Rim diameter	min. 14" (356 mm)				
Hub diameter	max. 5.5"				with hub adapter
Protection class	IP66, IP67				
Operating temperature					
Sensor	-40 °C to 150 °C				
Electronics	-40 °C to 105 °C				
Mechanical load	stress analysis according to BMW QV 36026				
Acceleration	max. 100 g				
Security	mechanical breakage protection				
Mounting bolts	32				
Adaption	custom specific adaption for every vehicle possible				

9.2 CRFX module (CRFX/WFT-2)

Parameter	Value	Remarks
Inputs	2	for two WFT measuring wheels
Terminal connection		
LEMO	2x LEMO.ERA.1E.306	measuring wheel connection
Input supply plug (female)	1x LEMO.EGE.1B.302	multicoded 2 notches, for optional individually power supply
EtherCAT connection	2x RJ45	system bus for expanded
Module connector	2x 20 pin	imc CRONOSflex components direct connection of modules (click) supply and system bus

Parameter	Value	Remarks
Channels	36 F _x , F _y , F _z , M _x , M _y , M _z Umdr, Drehz, Temp rot_f _x , rot_f _z , rot_m _x , rot_m _z Winkel, sin, cos Status, Aux	18 analog channels per measuring wheel: forces and moments revolutions, speed, temperature rotating coordinate system angle state, aux
Sampling rate	≤10 kHz	sample rate and filter settings apply to all channels of a socket
Filter (digital) characteristic frequency	low pass Butterworth, Bessel 5 Hz to 500 Hz 5 Hz to 1 kHz	individual selectable with Bessel with Butterworth
order	8th order	
Resolution	16 Bit	

Sensor supply for WFT-C^x or -C^{xs}

Parameter	Value (typ. / max.)	Remarks
Input supply voltage	10 V to 50 V DC	
Output voltage	12.2 V DC	no load, 25 °C
Output power	10 W (max.)	for each channel
Efficiency	typ. 83 %	full load, 25 °C
Capacitive load	>800 μF	per channel
Isolation	isolated	channel individual to housing and input nominal 60 V
Short-circuit protection	unlimited duration	automatic restart
Accuracy of output voltage	±1 %	at terminals, no load 25 °C
Temperature coefficient	typ. ±0.02 % / K	

Power supply	Value	Remarks
Input supply voltage	10 V to 50 V DC	
Power consumption	5 W plus 13 W per WFT	

Index

A

- adjustment 6, 53
- angle alignment 49
 - automatic 49
 - manual 51
- axial displacement 24
 - compensation 58

C

- calibration 6, 18
- CE 8
- CE Certification 6
- Certificates 6
- Change requests 6
- commissioning CRFX-WFT-2 44
- Condensation 14
- configuration imc STUDIO 44
- coordinate transformation 23
- CRFX/2000GP-WFT 30
- CRFX/2000GP-WFT-UPS 31
- CRFX/WFT-2 29
 - Technical Specs 67
- Custom adaptor 7
- Customer support
 - Tech support 6
- Customized cable manufacturing 7

D

- DIN-EN-ISO-9001 6

E

- ElektroG 8
- EMC 8
- energy sources 10

F

- FCC 8
- forces 21

G

- General terms and conditions 6
- Guarantee 6, 7

H

- Hotline
 - Tech support 6
- hub adapters 28

I

- imc WFT Assistant 59
- Industrial safety 12
- Industrial safety regulation 12
- ISO-9001 6

L

- Liability restrictions 7
- Limited Warranty 6

M

- Maintenance 6, 18
- measurement mode
 - mobile (rotary) 55
 - mobile (stationary) 56
 - stationary 57
- measurement preparation 48
- modified rim 28

O

- Operating personnel 11

P

- prepare measurement 48
- Product improvement 6

Q

- Quality Management 6

R

- Radial displacement 24
 - compensation 58
- Read sensor information 48
- repair 6
- Restriction of Hazardous Substances 8
- RoHS 8

S

- sample rate 26
- Service 18
 - Tech support 6
- service and maintenance 6
- service check 6
- Special hazards 12
- spirit level 49
- Standards
 - IATA 18
- Storage 18
- Symbols 9

T

- Tech support 6
- Telephone numbers
 - Tech support 6
- torques 21
- Transport 18

U

- Unpacking 14

W

- Warranty 6
- Waste on Electric and Electronic Equipment 8
- WEEE
 - Restriction of Hazardous Substances 8
- WFT
 - concept 20
- WFT Assistant 59
- WFT-2 67
- WFT-adapter 27
- WFT-channels and parameters 45

Z

- zero adjustment 26
- zero adjustment
 - mobile (rotary) 55
 - mobile (stationary) 56
 - stationary 57
- zero balance 53



An Axiometrix Solutions Brand

Contact imc

Address

imc Test & Measurement GmbH
Voltastr. 5
13355 Berlin

Phone: (Germany): +49 30 467090-0

E-Mail: info@imc-tm.de

Internet: <https://www.imc-tm.com>

Tech support

If you have problems or questions, please contact our tech support:

Phone: (Germany): +49 30 467090-26

E-Mail: hotline@imc-tm.de

Internet: <https://www.imc-tm.com/service-training/>

imc ACADEMY - Training center

The safe handling of measurement devices requires a good knowledge of the system. At our training center, experienced specialists are here to share their knowledge.

E-Mail: schulung@imc-tm.de

Internet: <https://www.imc-tm.com/service-training/imc-academy>

International partners

You will find the contact person responsible for you in our overview list of imc partners:

Internet: <https://www.imc-tm.com/imc-worldwide/>

imc @ Social Media

<https://www.facebook.com/imcTestMeasurement>

<https://www.youtube.com/c/imcTestMeasurementGmbH>

https://twitter.com/imc_de

<https://www.linkedin.com/company/imc-test-&-measurement-gmbh>